

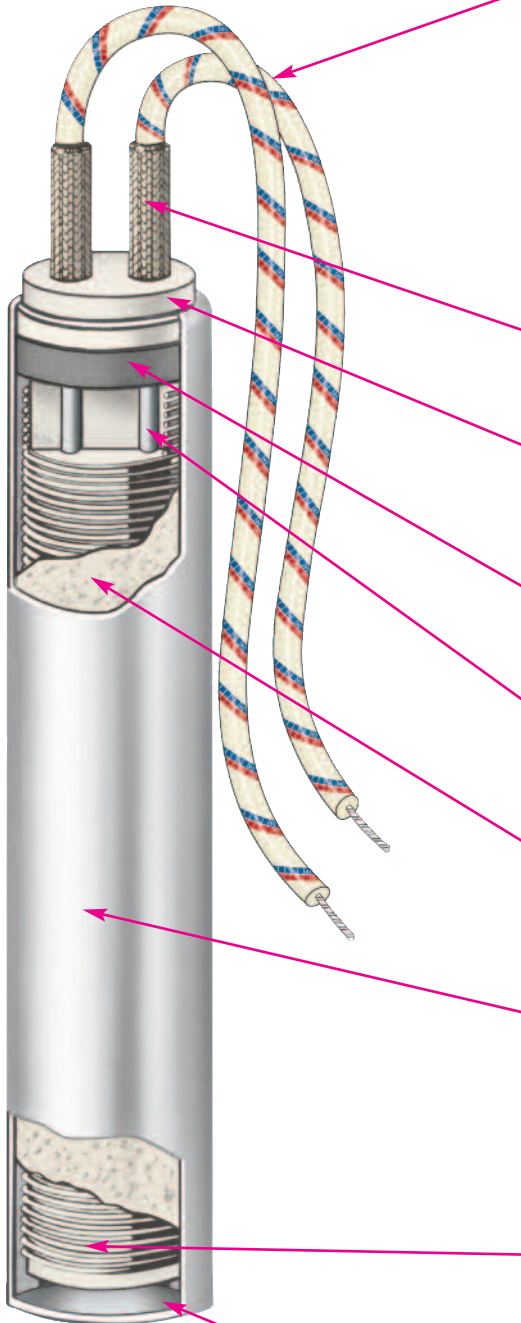

Hi-Density

CARTRIDGE HEATER FEATURES



A The standard termination for Hi-Density Cartridge Heaters is Type N, 10" (254 mm) long nickel conductor lead wires externally connected to 1-1/4" (32 mm) solid conductor terminal pins. The lead wires have fiberglass insulation and are UL approved for temperatures up to 482°F (250°C). Mica insulated UL approved wires for temperatures up to 842°F (450°C) are optional.



Note: To meet the requirements of your application we offer over 40 standard termination styles to select from that will solve many of the most common application problems. See pages 2-39 through 2-60.

B High temperature fiberglass sleeve provides maximum electrical insulation to the crimp connector used to splice the nickel conductors to the flexible leads.

C Ceramic end cap prevents nickel conductors from shorting out against sheath when sharp bending of the leads is required. The ceramic cap may be eliminated in some cases to optimize the heater watt density.

D Ceramic end cap and swaged-in lava plug protect the internal cartridge from outer contamination. Other types of seals can also be provided.

E Solid conductor terminal pins are used to ensure a good electrical connection between the nickel conductor lead wires and the resistance wire. They are sized for the maximum current rating of the heater.

F A high purity Magnesium Oxide (MgO) powder consisting of custom grain sizes is used to fill all remaining space inside the sheath. Heater is then swaged, which compacts the magnesium oxide grains into a solid mass, thereby increasing thermal conductivity and dielectric strength.

G Standard sheath material is 321 Stainless Steel. It provides high temperature strength up to 1200°F (650°C), good thermal conductivity, and resistance to corrosion and scaling. Alloy 321 is a Nickel-Chromium Stainless Steel modified with the addition of Titanium. For higher operating temperatures up to 1400°F (760°C) or corrosive immersion heating applications, Incoloy® 800 is available. Consult Tempco for other sheath materials.

H Grade "A" Nickel-Chrome resistance wire precisely wound on a high purity magnesium oxide core places the resistance wire as close to the inside of the sheath as possible while maintaining dielectric strength. This provides excellent heat transfer and long heater life with the highest possible watt densities.

I Welded end disc made from the same material as the sheath provides a positive seal against moisture and other contaminants.



Hi-Density Cartridge Heaters are UL recognized and CSA certified in many design variations under UL File Number E65652 and CSA File Number 043099.

If you require UL and/or CSA Agency Approval, please specify when ordering.



TEMPCO Offers the Most Comprehensive and Diverse Selection in Hi-Density Cartridge Heaters

Since Their Introduction in 1972, Hi-Density Cartridge Heaters Have Evolved and Today Offer a Multitude of Diverse Product Options:

1. **(HDC)** A Hi-Density cartridge heater in US sizes (see page 2-4).
2. **(HDM)** A Hi-Density cartridge heater in Metric sizes (see page 2-28).
3. **(HDP)** Pennybottom™, A Hi-Density cartridge heater with a Built-in Thermocouple and Flat Copper end disc. (see page 2-24).
4. **(HDL)** A Hi-Density cartridge heater designed with NPT Fittings for Immersion heating (see page 2-23).
5. **(HDB)** Bolt Heater, A Hi-Density cartridge heater designed for assisting in the assembly of large machinery (see page 2-61).

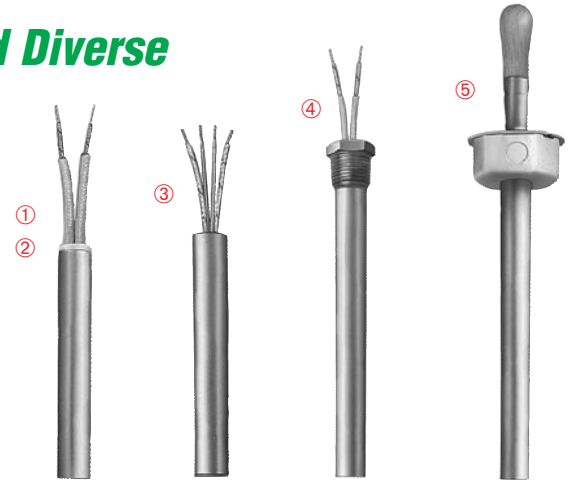

Hi-Density Cartridge Heaters provide maximum processing temperature capability

- * Higher watt densities permit smaller heaters to be used without sacrificing life expectancy. This results in up-front as well as long-term cost savings.
- * Swaged construction provides maximum support for the resistance wire and excellent heat transfer characteristics, improving the overall life expectancy of the cartridge heater.
- * Termination styles and special features allow customization to any application.
- * Applications up to 1400°F (760°C)

Typical Applications

- ✦ Plastic Extruders
- ✦ Hot Runner Molds
- ✦ Hot Stamping
- ✦ Medical Equipment
- ✦ Packaging Equipment
- ✦ Molds
- ✦ Aerospace
- ✦ Sealing Bags
- ✦ Semi-Conductor
- ✦ Plastic Molding
- ✦ Shoe Machinery
- ✦ Food Processing
- ✦ Heating Gases and Liquids
- ✦ Glue Guns
- ✦ Laminating Presses
- ✦ Platens
- ✦ Scientific Equipment
- ✦ Food Service Equipment

Hi-Density Cartridge Heaters are Classified in Two Distinct Categories

Multi-Purpose Use

The Multi-Purpose Use Cartridge Heaters represent Tempco's commitment to value-added customer service as we maintain in Stock over 65,000 Semi-Finished Hi-Density Cartridge Heater Substrates, offering a combination of over 1000 sizes in industry standard diameters and lengths ranging from 1" (25.4 mm) to 36" (914.4 mm) in a complete spectrum of wattages and operating voltages. Multi-Purpose Use Cartridge Heaters are the solution for a multitude of original equipment manufacturers (OEMs) or maintenance (MRO) applications.

Highly Engineered Specific Purpose Use

Tempco has been at the forefront of addressing the challenges of Original Equipment Manufacturers (OEMs) in a broad segment of diversified industries. As a company we are uniquely qualified and committed to providing value-added expertise in engineering and manufacturing capabilities that span over three decades of acquired knowledge, assisting customers in developing highly engineered specific use cartridge heaters for dependable and reliable performance. Let us provide the optimal solution to your thermal loop system and cartridge heater design challenges. Engineering assistance can be found on pages 2-5 through 2-7.

Available through the Terminator Program.
Complete details are found on pages 2-12 through 2-21.

Consult Us With Your Requirements.
We Welcome Your Inquiries.

Ordering Information

Custom
Manufactured



Custom Engineered/Manufactured Heaters

Because an electric heater can be very application specific, for sizes and ratings not listed, **TEMPCO** will design and manufacture a Hi-Density Cartridge Heater to meet your requirements. **Standard lead time is 3 weeks.**

Please Specify the following:

- Diameter
- Length
- Wattage
- Voltage
- Termination types (see pages 2-39 through 2-60)
- Lead Length
- Cable/Braid length
- Special Features
- Application Type
- Operating Temperature

Cartridge Heaters



Standard Specifications

Hi-Density Cartridge Heater Specifications

PERFORMANCE RATINGS

Max. Temperature: ♦1400°F (760°C)
Max. Watt Density: 100-300 W/in² (15.5-46.5 W/cm²)
 depending on heater size & operating temperature.

NOTE: The maximum operating temperature and the life expectancy of a cartridge heater is dependent on two main factors:

1. The maximum recommended sheath temperature (♦1200°F for a standard heater)
2. The maximum ambient temperature for the termination selected.

Consult Tempco if you require a recommendation for your application.

DIMENSIONAL SPECIFICATIONS

Nominal Diameter	1/8"		1/4"		5/16"		3/8"		1/2"		5/8"		3/4"		1"	
	in	(mm)	in	(mm)	in	(mm)	in	(mm)	in	(mm)	in	(mm)	in	(mm)	in	(mm)
Actual Diameter	.122	(3.10)	.246	(6.25)	.308	(7.82)	.371	(9.42)	.496	(12.60)	.621	(15.77)	.746	(18.95)	.996	(25.30)
Diameter Tolerance	±.002	(.051)	±.002	(.051)	±.002	(.051)	±.002	(.051)	±.002	(.051)	±.002	(.051)	±.003	(.076)	±.003	(.076)
Minimum Length	1.25	(31.8)	1	(25.40)	1	(25.40)	1	(25.40)	1	(25.40)	1	(25.40)	1-1/4	(31.75)	1-3/4	(44.45)
Maximum Length	12	(305)	36	(914)	36	(914)	48	(1219)	60	(1524)	72	(1829)	72	(1829)	72	(1829)
Length Tolerance Heaters up to 5" (127 mm) long	±3/32	(2.4)	±3/32	(2.4)	±3/32	(2.4)	±3/32	(2.4)	±3/32	(2.4)	±3/32	(2.4)	±1/8	(3.2)	±1/8	(3.2)
Length Tolerance Heaters over 5" (127 mm) long	—		±2% of Sheath Length													
Camber Tolerance Heaters to 12" (305 mm) long	—		0.010"(.254 mm) per foot of length													
Camber Tolerance Heaters over 12" (305 mm) long	—		0.020"(.508 mm) per foot of length													

A certain amount of Camber is unavoidable. With a slight force, Hi-Density Cartridge Heaters will flex enough to fit into a straight reamed hole.

ELECTRICAL SPECIFICATIONS

Nominal Diameter	1/8"	1/4"	5/16"	3/8"	1/2"	5/8"	3/4"	1"
Maximum Voltage	240	240	240	240	240	480*	480*	480*
Maximum Amperage (see next line for exceptions)	3.0	4.4	4.5	6.7	10.5	23	23	23
†Maximum Amperage for Types C1C, C1D, C2C, C2D, CS, F, M3, R1B, S1, S2, SA, W & W3 Terminations	—	3.0	3.0	5.5	7.6	9.7	9.7	9.7
Minimum Wattage at 120V on a 1" long Heater	—	50	45	45	50	50	—	—
Minimum Wattage at 120V on a 2" long Heater	5	20	20	20	20	20	20	20
Maximum Wattage at 120V	360	525	540	800	1260	2760	2760	2760
Maximum Wattage at 240V	720	1050	1080	1600	2520	5520	5520	5520
Maximum Wattage at 480V	—	—	—	—	—	11,000	11,000	11,000
Wattage Tolerance	+10,-15%		Plus 5%, Minus 10%					
Resistance Tolerance	+15,-10%		Plus 10%, Minus 5%					

†Current carrying capacities are for ambient temperatures up to 482°F (250°C) with mica insulated lead wires.

*480V when applicable. Consult Tempco.

LENGTH TOLERANCE FOR:

- LEAD WIRES
- WIRE BRAID LEADS
- ARMOR CABLE LEADS

Up to 36": -1/2", +1" (-12.7 mm, +25.4 mm)

36" to 72": -1", +2" (25.4 mm, +50.8 mm)

Above 72": ±4" (101.6 mm)



Note: Specifications detailed on this page are standard. Consult Tempco if your application requires tighter tolerances or has other special requirements.

TEMPERATURE COEFFICIENT OF RESISTANCE

The electrical resistance (ohms) of the heater resistance wire increases with temperature rise.

Tempco standard Hi-Density Cartridge Heaters are manufactured with ohms (cold ohms) 3.3% lower than the actual calculated ohms (hot ohms) to compensate for this increase.

AVAILABLE ELECTRICAL FEATURES

Diameter	Dual Volts	3-Phase	Dual Circuits	Multiple Heat Zones (maximum 3 zones)
1/8"	No	No	No	No
1/4"	No	No	No	No
5/16"	No	No	No	No
3/8"	Yes*	No	No	Yes*
1/2"	Yes*	Yes	Yes	Yes*
5/8"	Yes	Yes	Yes	Yes
3/4"	Yes	Yes	Yes	Yes
1"	Yes	Yes	Yes	Yes

Consult factory for maximum wattages and voltages.

* Heaters may require a larger diameter transition area at lead end.



Recommendations for Improving the Life of Hi-Density Cartridge Heaters

Tempco Hi-Density Cartridge Heaters have been widely used in many demanding and diverse applications since 1972. The commonly used basic applications are platen, plastic mold and die heating, liquid immersion and air heating.



Note: Selection of the wrong termination for a particular application is the primary reason for all heater failures. However, failure to consider other important criteria can also have a negative effect on the life of the heater. To get the best performance and assure long life, it is important to carefully evaluate the following factors.

Operating Temperature

Operating temperature of a heater is a major factor in determining the life expectancy of a heating element. The heater life depends on the actual temperature of the resistance wire within the heater and not on the process operating temperature. The graph in Fig. 1 demonstrates the proper relationship between operating temperature and watt density; the higher the operating temperature, the lower the maximum recommended watt density.

Heater Watt Density

Cartridge heater watt density is defined as the wattage dissipated per square inch of the heated sheath surface. For a particular application a heater's watt density governs internal resistance wire temperature, which determines the outer sheath temperature. These factors are critical to the proper heating of the application and to the life expectancy of the heater. Special construction features that promote excellent heat transfer permit Hi-Density Cartridge Heaters to operate at higher watt densities while maintaining the lowest possible resistance wire temperatures of any style cartridge heater.

Heater watt density (w/in²) is calculated using the following formula:

$$\text{Watt Density} = \frac{\text{Heater wattage}}{\text{Heated length} \times \text{Heater diameter} \times 3.1416}$$

Heated length is the overall length of the heater minus any unheated (cold) sections. Standard Type N, Hi-Density cartridge heaters have 3/8" at the lead end and 1/4" at the disc end unheated. This would mean a 6" long heater would have 5-3/8" effective heated length. Unheated sections vary with type of heater termination. For descriptions of terminations and options, see pages 2-39 through 2-60.

The graph in Fig. 1 shows the maximum recommended watt density for Hi-Density Cartridge Heaters when used in a steel platen. Watt density limitations for various materials are given in the engineering section of this catalog. For liquid immersion heaters the maximum watt density depends on the type of liquid being heated. The more viscous, or thicker the liquid, the lower the maximum watt density. Higher watt density can cause the liquid to carbonize and accumulate on the heater sheath, which will cause premature heater failure. It is advisable to use heaters that have watt densities below the maximum recommended watt density to get the longest heater life. If the actual heater watt density is close to the maximum recommended watt density, you can correct the problem by:

1. Increasing the number, diameter and length of heaters.
2. Lowering the total wattage; however, this may increase the heat-up time.
3. Obtaining tighter fit (see Fig. 2 — Determining Fit).

A Hi-Density cartridge heater designed at the maximum recommended watt density allows the smallest heater to be used to obtain the required wattage with good service life. All things being equal, using a lower watt density heater will typically provide optimized service life.

FIG. 1 Recommended Watt Density for Heating Metal Parts

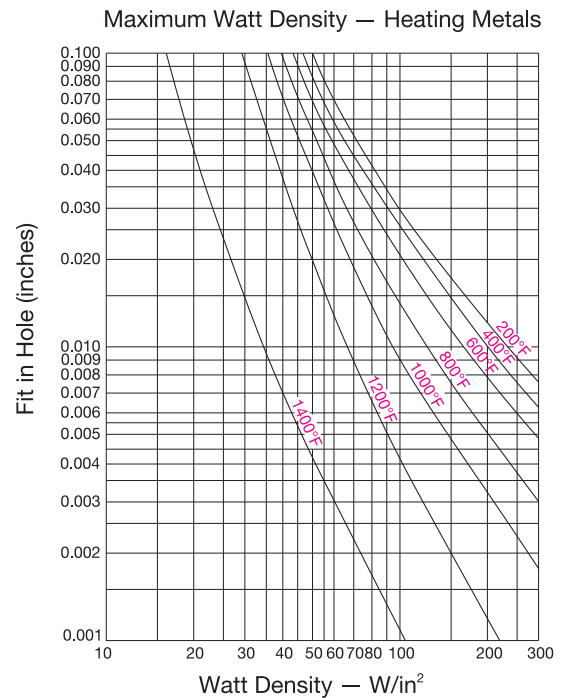

The graph shows the recommended maximum watt density for Tempco Hi-Density cartridge heaters at different operating temperatures and fit, when the heater is installed in an oxidized mild steel block. The thermocouple is located 1/2" from the heater. When heating other materials, the data needs to be extrapolated based on the thermal conductivity of the material. Consult Tempco with your requirements.

FIG. 2 Determining Fit

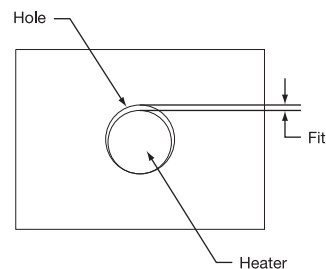



Hi-Density

Recommendations for Improving the Life of Hi-Density Cartridge Heaters

Continued from previous page...

Determining Fit

When heating a platen, mold, die or hot runner probe with Hi-Density Cartridge Heaters inserted into drilled holes, fit is an important factor in determining the life expectancy of the heater. Fit is the difference between the minimum diameter of the cartridge heater and the maximum diameter of the hole. Unheated sections on a Hi-Density cartridge may be smaller in diameter due to swaging. To determine fit, use the smallest diameter on the heated length only.

Example: A 3/8" nominal OD Hi-Density cartridge heater has an actual diameter of .371" \pm .002, which translates to a minimum diameter of .369". If used in a .376" \pm .002 hole, the fit would be .009" (.378" - .369" = .009").

When medium watt density heaters (less than 60 watts per square inch) are used in low temperature applications (less than 600°F [315°C]) general purpose drills are commonly used to drill holes. The typical hole size may be .003" to .008" over the drill size. For higher watt density and/or higher temperature applications, we recommend that the holes are drilled and reamed for the tightest possible fit. In applications where precise temperature control and heat transfer properties are required, Hi-Density cartridge heaters can be centerless ground to \pm .0005".

Although a tighter fit is desirable to efficiently transfer heat and to get long heater life, a looser fit will aid in installing and removing heaters, especially long heaters. We recommend that you apply Tempco's BNS anti-seize cartridge heater coating as it will improve heat transfer and will make the removal of heaters easier.

The graph in Fig 1. (page 2-5) shows the effect of fit in determining the maximum recommended watt density on a steel platen. As it is indicated in the graph, the tighter the fit, the higher the maximum recommended watt density.

Temperature Control and Location of Temperature Sensing Device

In order to better control the heater temperature and hence the resistance wire temperature, use of an appropriate temperature control and the proximity of the heater to the sensor is very important. The graph in Fig. 1 (page 2-5) shows the effect of operating temperature in determining the maximum recommended watt density on a steel platen where the sensor is located 1/2" from the heater. Higher watt density heaters can generate heat faster than the surrounding area's ability to dissipate heat. This creates a thermal lag between the heater and the sensor. The closer the sensor to the heater, the better you can control the heater temperature. By keeping the sensor further from the heater, temperature gradients of several hundred degrees can be observed in many applications, especially during initial start-up and heavy thermal cycling. Although the set operating temperature may be low, the heater may be running at a very high temperature. This is a common cause of heater failure. This can be minimized using time proportional and PID functions of the temperature controllers. See Section 13 for temperature controllers and Section 14 for thermocouples and sensors.

Power Control

Power control methods affect the life expectancy of heating elements. In general, although economical, on-off controls increase thermal fatigue and oxidation rate on heating elements by causing wide temperature swings of the internal heating element. Silicon Controlled Rectifiers (SCRs), Mercury Relays and Solid State Power Controls can increase the life expectancy of heating elements by reducing the temperature swings of the internal heating element. See Section 13 for power controls.

Common Causes of Cartridge Heater Failures

Contamination

Contamination is a major cause of heater failure. Moisture, hydraulic oils, and melted plastic are the most common contaminants that are seen on failed heaters. Since the magnesium oxide insulation in a Hi-Density heater is hygroscopic in nature, moisture is easily absorbed into the heater and typically results in premature heater failure. Moisture absorption during machine washdown or cleanup also is a frequent problem. These contaminants, which are electrically conductive, will short out the heater. Most probably, the failures will be at the lead end of the heater and in some cases can split or blow a hole on the heater sheath. The disc end of a Hi-Density cartridge heater is welded shut with a stainless steel disc.

Generally, contaminants enter the heater through the lead end of the heater. The high temperature lead wires used on Hi-Density heaters have fiberglass or mica insulation. Oil and moisture can wick through the insulation on the lead wire into the heater. Tempco offers a wide variety of terminations to avoid this problem, including epoxy seals, Teflon® seals, convoluted cables, welded end discs, Teflon® insulated lead wires and SJO cable. However, there are temperature limitations on many of these terminations.



Note: If you should encounter premature cartridge heater failure, consult Tempco. Our team of professionals will have the solution to your problem.

Excessive Flexing of Leads

Tempco Hi-Density heaters use flexible grade A nickel stranded lead wires with fiberglass or mica insulation. On certain terminations the lead wires are connected externally to solid nickel conductor pins. In applications where there is excessive movement or vibration, the solid pins could break due to fatigue. A simple solution is to give enough slack on the leads to minimize the stress on the solid pins or provide an internal lead wire connection within the heater. Tempco also offers strain relief brackets and springs to prevent this problem.

Where heater leads can wear out by abrasion due to excessive flexing of the leads, Tempco offers several abrasion resistant terminations. See pages 2-41 through 2-47.

Lack of Heat Sink

Hi-Density heaters are designed with minimum unheated (cold) sections. If the heated sections project from the platen or mold, these sections will get extremely hot due to lack of heat transfer. This will lead to premature heater failure. Tempco can manufacture heaters with cold sections anywhere along the length of the heater to prevent overheating of the heater sheath.

When a Hi-Density heater is used as a liquid immersion heater, make sure the heater's sheath length is completely immersed in the liquid. The heater lead end should not be immersed in liquid, since most of the lead end seals are only moisture resistant, not moisture proof.



Recommendations for Improving the Life of Hi-Density Cartridge Heaters

High Operating Temperature

Tempco Hi-Density heaters are designed to operate at sheath temperatures up to 1400°F (760°C). When process temperatures approach the maximum heater sheath temperature, make sure the sheath temperature doesn't exceed its limitations. Location of the thermocouple and the type of temperature and power controls are factors that affect sheath temperature and potential overshoot conditions.

Although the heater is designed to run at temperatures up to 1400°F (760°C), heater lead wires and terminations are rated for much lower temperatures. Care should be taken to make sure that the heater lead end temperatures do not exceed their limitations. Heaters can be made longer with unheated sections at the lead end to bring the lead end out of the high temperature area. Tempco can also provide you with a high temperature wiring harness, which can withstand temperatures up to 1400°F (760°C). See page 15-5 in the accessories section for details.



Note: As explained in the above paragraphs, the single major cause for cartridge heater failure is the selection of the wrong type of heater lead end termination for the specific application. To assist you in selecting the right termination type, pages 2-39 through 2-57 give detailed descriptions of over 40 terminations designed to solve many of the common application problems. If you need further assistance, consult Tempco.

High Wattage Rating

Heaters with very high wattage ratings can create temperature overshoots, uneven temperature distribution and high heater sheath temperatures, causing premature heater failure.

For liquid immersion heaters, maximum watt density depends on the type of liquid being heated. The heavier or thicker the liquid, the lower the maximum watt density. Higher watt density can cause the liquid to carbonize and accumulate on the heater sheath, which will cause premature heater failure.

Scale and Sludge Buildup

In liquid immersion applications, periodic cleaning of the heater sheath is necessary to remove any scale buildup on the sheath. Scale can accumulate on the sheath and cause the heater to overheat and fail. When used to heat liquid in a tank, be sure to clean any sludge from the bottom of the tank. A heater sheath covered with sludge will overheat and fail.

Important Installation Considerations

- For closest fit and best heat transfer, use reamed holes.
- When possible, drill holes through the object being heated. This will make heater removal easier.
- When using an anti-seize coating like Tempco's BNS spray or paste, **do not apply** over lead wires or any other current carrying conductors.
- When using insulated tape or sleeving, check to make sure it is rated for the temperature of the application. Lower temperature rated materials can contain an adhesive or binder that can carbonize and become electrically conductive.
- When using heaters near their maximum recommended watt density, it is recommended that the temperature sensing probes be at maximum 1/2" from the heater sheath.
- Lead wires should not be located in the hole containing the cartridge heater during operation. This may cause the lead wires to be exposed to temperatures above their rated temperature.
- When used in a vacuum application, make sure the lead end of the heater is outside the vacuum. If the lead has to be in the vacuum, consult Tempco for specific recommendations.
- Many applications will subject a heater's electrical terminations to one or more of the following potentially damaging conditions:
 - Moisture
 - Oil and other contaminants
 - Flexing
 - Abrasion
 - High temperature



Note: To protect the heater from damage in these harsh environments, Tempco has a wide selection of terminations and options available. See pages 2-39 through 2-60 for details.

BNS Anti-Seize Cartridge Heater Coating

This high temperature, electrically insulating and thermally conductive coating will minimize oxidation and improve heat transfer from heater to the object being heated.

Brush a thin layer of paste or spray lightly over the cartridge heater prior to inserting the heater into a hole.



Do not apply over lead wires or other bare current carrying conductors, since the water in the paste and spray can cause an electrical short circuit.



13 oz.
Aerosol spray can
Part Number:
CML00010

- * Temperature Range 1562°F (850°C)
- * High Heat Transfer



4 oz.
Paste w/brush applicator top
Part Number: CML00020

- * Temperature Range 1562°F (850°C)
- * High Heat Transfer

Note: Formulated to assist in the removal of cartridge heaters.

All Items Available from Stock





Highly Engineered Custom Manufactured Specific Use Cartridge Heaters

Meeting the Challenges of Original Equipment Manufacturers with Custom Engineering

Tempco has been at the forefront of addressing the challenges of original equipment manufacturers (OEMs) in diversified industries, when dependable and reliable performance of custom engineered cartridge heaters is crucial to the overall operating efficiency and quality of their equipment and machinery.

Tempco is a company uniquely qualified and committed to providing value-added expertise in engineering and manufacturing that spans over four decades of acquired knowledge, assisting customers in developing highly engineered specific use cartridge heaters for equipment and/or machinery systems.

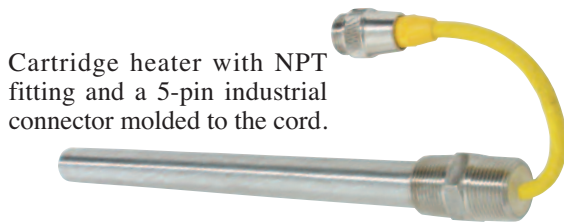

Cartridge heater with NPT fitting and a 5-pin industrial connector molded to the cord.



Cartridge heater for continuous air heating application with Incoloy® sheath, custom machined fitting and silicone rubber moisture barrier.



Cartridge heater with built-in thermal fuse and ground wire for X-Ray processing equipment.



Cartridge heater with built-in thermostat, pipe fitting and ground leads for oil heating in waste handling equipment.



Finned Cartridge Oil Immersion Heater with a liquid-tight electrical termination.

Complete a New Project on Time, Improve Efficiencies and Reduce Cost

Consult Tempco, your strategic partner, in the early stages of a new project requiring cartridge heaters, or to improve a troublesome existing application. By doing so you allow Tempco to place at your disposal our team of professionals, offering you our vast knowledge in product design and manufacturing expertise. We can provide you with the optimal solution to your thermal loop system and cartridge heater design challenges.

Tempco offers you the perfect balance in quality and service with value-added technology. These pictures depict a small sampling of the cartridge heaters we have developed for special applications. Put our knowledge and experience to work for you.

Our capabilities are limited only by your imagination. Consult us with your requirements. We welcome your inquiries.

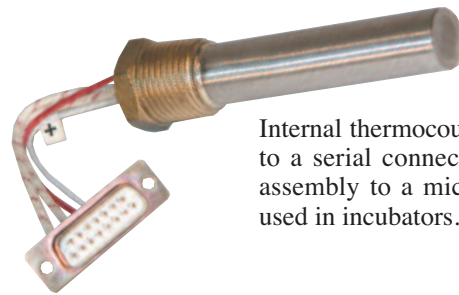

Internal thermocouple is wired to a serial connector for easy assembly to a microprocessor used in incubators.



Incoloy® fitting and seamless Incoloy® 800 sheath material used in an aviation application.



Straight armor cable and adjustable bayonet cap for easy assembly.

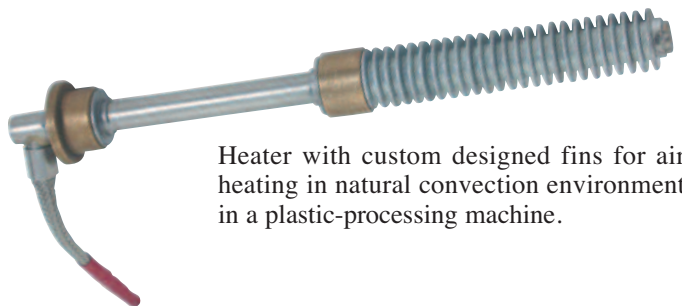

Heater with custom designed fins for air heating in natural convection environment in a plastic-processing machine.



Highly Engineered Custom Manufactured Specific Use Cartridge Heaters



The heater has a header cap as an integral part of the fitting. Leads exit through small holes that are sealed with epoxy for moisture protection.

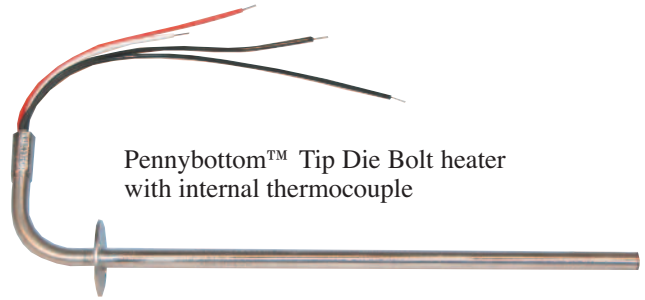
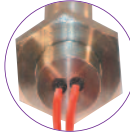

Pennybottom™ Tip Die Bolt heater with internal thermocouple



Heater designed to run continuously at 1202°F (650°C); built-in isolated thermocouple and ground wire.

Heater for medical diagnostic instruments has an integrated heat sink and thermal fuse.

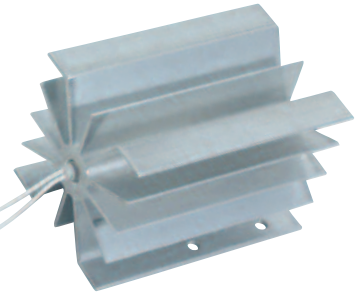

SJO cord and molded plug for automotive air conditioning recharging units.

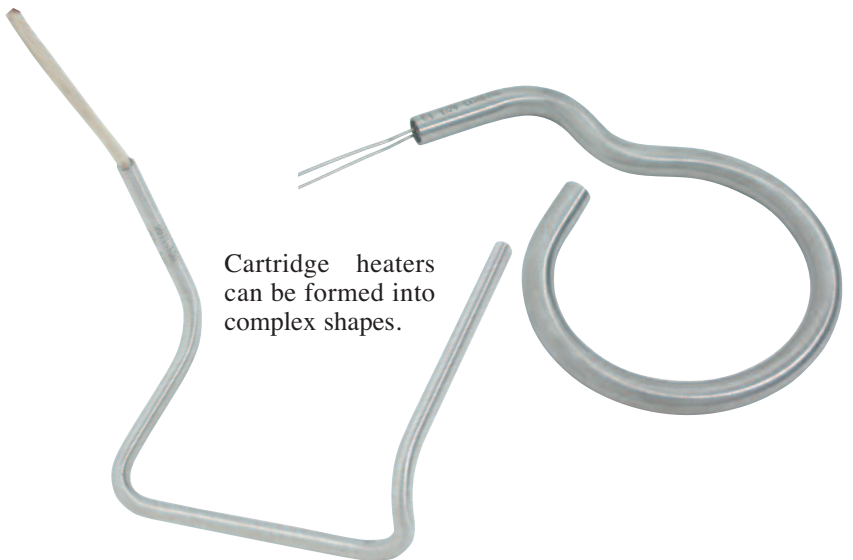

Cartridge heaters can be formed into complex shapes.

Optional Inspection Services and Test Reports

Die Penetrant Test

This non-destructive testing can detect imperfections in weld joints. For critical applications, each individual heater's weld joints by end cap and fittings can be tested. Certified test reports will be sent with each shipment.

Hydrostatic Pressure Test

Cartridge heaters with attached pipe fittings can be pressure tested to your specifications at Tempco. Our in-house testing capabilities can ensure that your products meet your exact specifications.

Electrical Tests

Our state of the art test meter can perform AC/DC dielectric withstand test (Hypot) up to 5000 volts while measuring leakage current in micro amps. It can also measure Insulation resistance (IR) and heater element resistance. Heaters can be serialized and test reports can be sent with each shipment if required.

*Consult Tempco with Your Requirements.
We Welcome Your Inquiries.*

Cartridge Heaters



Hi-Density Miniature

Hi-Density 1/8" Diameter Miniature Cartridge Heaters

PERFORMANCE RATINGS

Max. Temperature: 1200°F (649°C)

Max. Watt Density: 100-200 W/in² (15.5-31 W/cm²)
depending on operating temperature.

NOTE: The maximum operating temperature and the life expectancy of a cartridge heater is dependent on two main factors:

1. The maximum recommended sheath temperature
 2. The maximum ambient temperature for the termination selected
- Consult Tempco if you require a recommendation for your application.

DIMENSIONAL SPECIFICATIONS

Nominal Diameter	1/8"	
	in	(mm)
Actual Diameter	.122	(3.10)
Diameter Tolerance	±.002	(.051)
Minimum Length	1.25	(31.8)
Maximum Length	12	(305)
Length Tolerance Heaters up to 5" (127 mm) long	±3/32 (2.4)	
Length Tolerance Heaters over 5" (127 mm) long	±2% of Sheath Length	

SHEATH MATERIAL

Type 304 Stainless Steel

ELECTRICAL SPECIFICATIONS

Nominal Diameter	1/8"
Maximum Voltage	240
Maximum Amperage	3.0
Maximum Wattage at 120V	360
Maximum Wattage at 240V	720
Wattage Tolerance	+10,-15%
Resistance Tolerance	+15,-10%

1/8" Actual .122" (3.10 mm) Diameter Hi-Density Cartridge Heaters with Type N Termination (10" leads)

Sheath Length		Watts	Watt Density		Part Number	
in	mm		W/in ²	W/cm ²	120V	240V
1¼	31.8	25	90	14	HDC19100	—
1¼	31.8	35	126	20	HDC19101	—
1½	31.8	50	180	28	HDC19102	—
1½	38.1	30	80	12	HDC19103	—
1½	38.1	60	160	25	HDC19104	—
2	50.8	40	70	11	HDC19105	—

Sheath Length		Watts	Watt Density		Part Number	
in	mm		W/in ²	W/cm ²	120V	240V
2	50.8	50	87	13	HDC19106	HDC19112
2	50.8	100	175	27	HDC19107	HDC19113
2½	63.5	50	68	11	HDC19108	—
3	76.2	60	64	10	HDC19109	—
3½	88.9	70	62	10	HDC19110	—
4	101.6	80	60	9	HDC19111	HDC19114



Note: 1/8" Diameter Hi-Density Cartridge Heaters are made-to-order only.
Standard lead time is 3 weeks.

Custom Engineered/Manufactured 1/8" Hi-Density Cartridge Heaters

(Refer to pages 2-2 through 2-9)

Because cartridge heaters can be very application specific, consult Tempco with your special requirements. For sizes, electrical ratings and any other design features required but not listed in the catalog, Tempco will custom engineer and manufacture to your specifications.

Consult Us with Your Requirements. We Welcome Your Inquiries.

**Custom
Manufactured**





1/8" Diameter Cartridge Heaters Termination Types

Type N External Pins with Leads (Standard Termination)

- Minimum 1/4" cold section at lead end is required
- 24 ga ultralead leads temperature rating: 482°F (250°C)
- Leads externally crimped to nickel pins
- **Standard** 10" (254 mm) leads. Specify longer leads.



Type F Internally Connected Flexible Leads

- Minimum 1/2" cold section at lead end is required
- High temperature fiberglass leads temperature rating: 842°F (450°C)
- Maximum Voltage: 120V
- **Standard** 10" (254 mm) leads. Specify longer leads.



Type M3 Teflon® End Plug Seal with Teflon® Leads

- Minimum 1/2" cold section at lead end is required
- 24 ga Teflon® insulated leads temperature rating: 392°F (200°C)
- Moisture resistant swaged Teflon® seal
- **Standard** 10" (254 mm) leads. Specify longer leads.



Type C1B SS Cable, Mechanically Fastened

- Minimum 1/4" cold section is required
- Provides maximum protection for abrasive environment
- Maximum Voltage: 120V
- **Standard** 10" (254 mm) cable over 12" (305 mm) leads. Specify longer leads or cable.



Type W SS Braid, Mechanically Fastened

- Minimum 1/4" cold section is required
- Offers sharp bending and abrasion protection
- Maximum Voltage: 120V
- **Standard** 10" (254 mm) cable over 12" (305 mm) leads. Specify longer leads or cable.



1/8" Diameter Cartridge Heaters Mounting Options

Type R4 Bent Cartridge

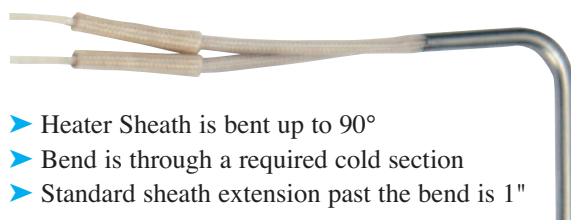

- Heater Sheath is bent up to 90°
- Bend is through a required cold section
- Standard sheath extension past the bend is 1"

Type MFR Mounting Flange

- 1" diameter; 2 × 9/64" mounting holes are standard
- Other sizes available



Custom Terminated Multi-Purpose Use Cartridge Heaters from the Terminator Program

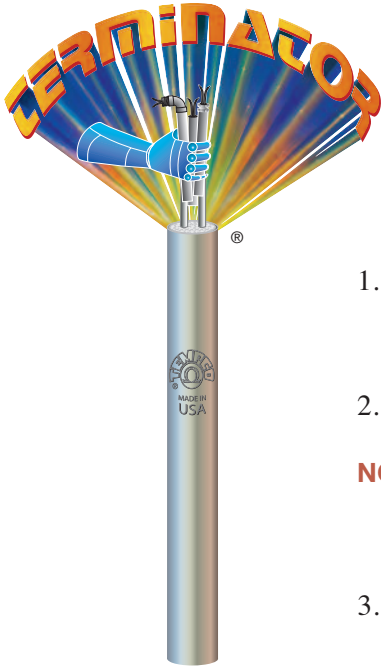

Tempco stocks over 1000 different Semi-Finished Hi-Density Cartridge Heaters in diameters 1/4", 5/16", 3/8", 1/2", 5/8" and 3/4".

These cartridge heaters are semi-finished (substrates), offering you the option to finish them by choosing from 19 program-qualified lead end terminations and options. Cartridge heaters will be ready for shipment within 1 to 3 days, depending on the termination/option selected.

Ordering Information – Follow These Simple Steps

1. Select an available 1/4" through 3/4" Hi-Density cartridge heater from the stock lists on pages 2-14 through 2-21. The Part Numbers in the tables are for heaters with termination Type N (10" long externally connected lead wires). **Call Tempco for part numbers for stock heaters with other Terminator Program terminations.**
2. Refer to the Program-Qualified Lead Terminations Reference Photos below and on page 2-13 to select the cartridge heater termination type best suited for your application.

NOTE: Type "N" (10" long externally connected plain lead wires) is the most common termination applied in the Terminator program. **If a termination other than Type N is selected, a new permanent part number will be assigned when your order is placed.**

3. Specify your lead requirements in the event that the standard supplied lengths for Plain Leads (10"), Braid or Armor Cable (10" over 12" leads) are not suited for your application.
4. Specify the Quantity.

These Program-Qualified Lead Terminations and Options for Stock Cartridge Heater Substrates will ship Same or Next Day when ordered before 2PM (CST).

Terminations

Type N

Standard Leads
(page 2-39)

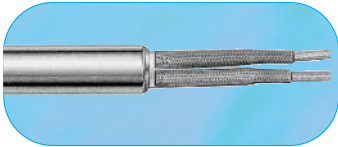

Type B

Ceramic Bead Insulation
(page 2-48)

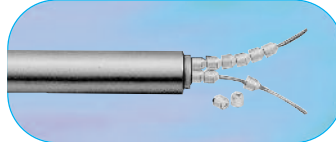

Type BL

Ceramic Bead and Leads
(page 2-48)

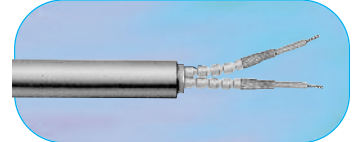

Type C1A & C1B only
Straight Armor Cable
(page 2-43)

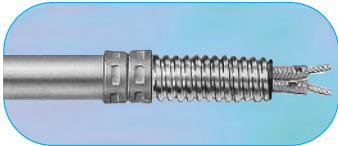

Type C2A & C2B

Right-Angle Armor
Cable with Copper Elbow
(page 2-47)

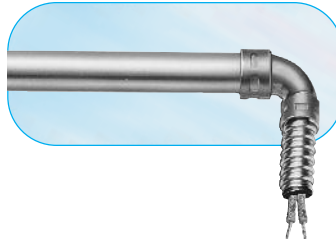

Type R1A

Right-Angle Leads with
Copper Elbow
(page 2-44)

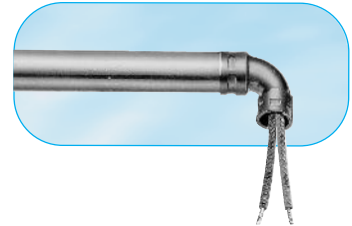

Options

Type MFR

Mounting Flange Round
(page 2-52)

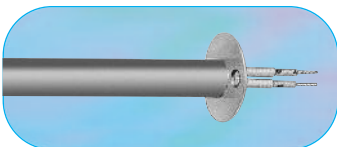

Type LR

Locating Ring
(page 2-52)

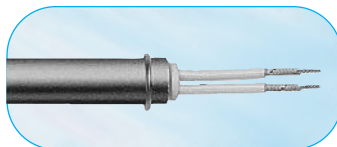

Type PS

Pull Strap
(page 2-52)

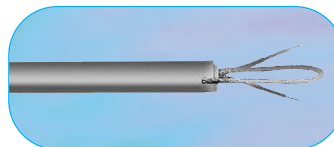

Type P

Quick Disconnect Plug
(page 2-56)

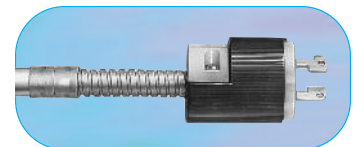



*These Program-Qualified Lead Terminations and Options
for Stock Cartridge Heater Substrates
will ship 2nd or 3rd Day when ordered before 2PM (CST).*

Terminations

Type W
Straight Wire Braided Leads
(page 2-42)

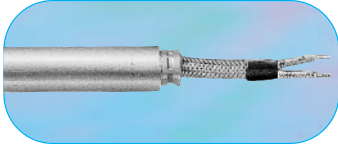

Type M2A & M2E
Potted Lead End Seal
(Cement Only)
(page 2-40)

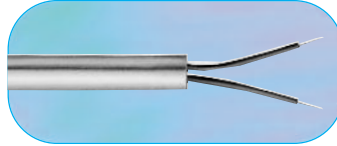

Type CMB & CMP
Single Threaded Fitting
(page 2-50)

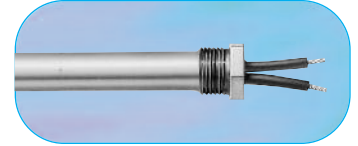

Type W1A & W1B
Right-Angle Wire Braided Leads
(page 2-46)

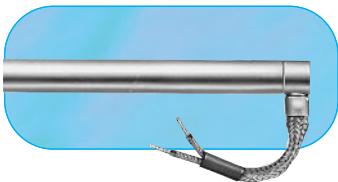

Type C3A, C3B, C3C & C3D
Right-Angle Armor Cable
(page 2-47)

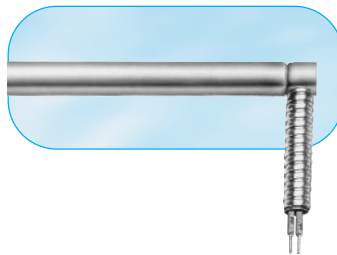

Type R2A & R2B
Right-Angle Leads
(page 2-45)



Options

Type R3
Angled Sheath Extension
(Cement Potting Only)
(page 2-53)

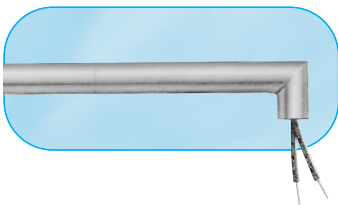

Type E1
General Purpose Box
(page 2-54)



Type GL
Ground Lead Sheath
(page 2-59)

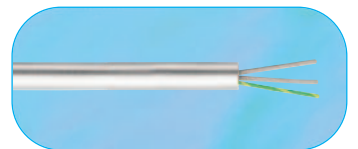

*Complete specifications and details on these terminations can be
found on the specified catalog page numbers.*



Custom Engineered/Manufactured Hi-Density Cartridge Heaters

(Refer to pages 2-2 through 2-9)

Because cartridge heaters can be very application specific, consult Tempco with your special requirements. For sizes, electrical ratings and any other design features required but not listed in the catalog, Tempco will custom engineer and manufacture to your specifications.

Consult Us with Your Requirements. We Welcome Your Inquiries.

Cartridge Heaters



Hi-Density

STOCK — Immediate Delivery through the TERMINATOR Lead Conversion Program



1/4" Actual .246" (6.25 mm) Diameter Hi-Density Cartridge Heaters

Part Numbers listed are for stock Cartridge Heaters terminated with 10 inch long leads (Type N Termination). Other Terminator Program terminations and options can also be applied to stock heaters (see Ordering Information).

Sheath Length in mm	Watts	Watt Density		Part Number	
		W/in ²	W/cm ²	120V	240V
1 25.4	50	127	20	HDC00001	—
1 25.4	80	204	32	HDC00002	—
1 25.4	100	255	40	HDC00003	HDC00004
1 25.4	150	382	59	HDC00005	—
1 1/4 28.6	100	204	32	HDC00006	—
1 1/4 31.8	50	85	13	HDC00007	—
1 1/4 31.8	75	127	20	HDC00008	—
1 1/4 31.8	100	170	26	HDC00009	—
1 1/4 31.8	125	212	33	HDC00010	—
1 1/4 31.8	150	255	40	HDC00011	HDC00012
1 1/4 31.8	200	340	53	—	HDC00013
1 1/4 31.8	225	382	59	—	HDC00014
1 1/2 38.1	50	64	10	HDC00015	—
1 1/2 38.1	75	92	14	HDC08691	—
1 1/2 38.1	100	127	20	HDC00016	HDC00017
1 1/2 38.1	150	191	30	HDC00018	HDC00019
1 1/2 38.1	175	223	35	HDC00020	HDC00021
1 1/2 38.1	200	255	40	HDC00022	HDC00023
1 1/2 38.1	250	318	49	—	HDC00024
1 1/4 44.5	75	76	12	HDC00025	—
1 1/4 44.5	150	153	24	HDC00026	—
1 1/4 44.5	300	306	47	—	HDC00027
2 50.8	50	42	7	HDC00028	—
2 50.8	80	68	11	HDC00029	—
2 50.8	100	85	13	HDC00030	HDC00031
2 50.8	125	106	17	HDC00032	HDC00033
2 50.8	150	127	20	HDC00034	HDC00035
2 50.8	200	170	26	HDC00036	HDC00037
2 50.8	250	212	33	HDC00038	HDC00039
2 50.8	300	255	40	—	HDC00040
2 1/4 57.2	200	146	23	HDC10139	HDC00041
2 1/2 63.5	150	95	15	—	HDC00042
2 1/2 63.5	200	127	20	HDC00043	HDC00044
2 1/2 63.5	250	159	25	HDC00045	HDC00046
2 1/4 69.9	200	113	18	—	HDC00048
3 76.2	75	38	6	HDC00049	—
3 76.2	100	51	8	HDC00050	HDC00051
3 76.2	125	64	10	—	HDC00052
3 76.2	150	76	12	HDC00053	HDC00054
3 76.2	200	102	16	HDC00055	HDC00056

Sheath Length in mm	Watts	Watt Density		Part Number	
		W/in ²	W/cm ²	120V	240V
3 76.2	250	127	20	HDC00057	HDC00058
3 76.2	300	153	24	HDC00059	HDC00060
3 76.2	350	178	28	—	HDC00061
3 1/2 88.9	200	85	13	—	HDC00062
3 1/2 88.9	300	127	20	HDC00063	HDC00064
3 3/4 95.3	300	118	18	—	HDC00065
4 101.6	100	36	6	HDC00066	—
4 101.6	150	55	9	HDC00067	—
4 101.6	175	64	10	HDC00068	HDC00069
4 101.6	200	73	11	HDC00070	HDC00071
4 101.6	250	91	14	HDC00072	HDC00073
4 101.6	300	109	17	HDC00074	HDC00075
4 101.6	400	146	23	—	HDC00076
4 1/2 114.3	125	40	6	HDC00077	—
4 1/2 114.3	200	64	10	HDC00078	—
4 1/2 114.3	500	159	25	—	HDC00079
5 127.0	200	57	9	—	HDC00080
5 127.0	250	71	11	—	HDC00081
5 127.0	300	87	14	HDC22940	—
5 127.0	350	99	15	HDC00082	HDC00083
5 127.0	400	113	18	HDC00084	HDC00085
5 1/4 146.1	350	85	13	HDC00086	HDC00087
6 152.4	150	35	5	HDC00088	—
6 152.4	200	46	7	—	HDC00089
6 152.4	300	69	11	HDC00090	HDC00091
6 152.4	400	93	14	HDC00092	HDC00093
6 152.4	450	104	16	HDC00094	HDC00095
6 152.4	600	139	22	—	HDC00096
6 1/2 165.1	500	106	17	HDC00097	HDC00098
7 177.8	500	98	15	HDC20502	—
7 177.8	600	118	18	—	HDC00099
7 1/2 190.5	525	95	15	HDC00100	—
8 203.2	300	51	8	HDC00101	—
8 203.2	600	102	16	—	HDC00102
9 228.6	675	101	16	—	HDC00103
9 1/2 241.3	525	74	12	HDC00104	—
10 254.0	750	101	16	—	HDC00105
11 279.4	600	73	11	—	HDC00106
13 330.2	725	74	12	—	HDC00107

Ordering Information

Order by Part Number for stock Cartridge heaters with Type N termination. Call Tempco for part numbers for stock heaters with other Terminator Program terminations and options (see pages 2-12 & 2-13).

Custom Engineered/Manufactured

Cartridge Heaters can be application specific; therefore for sizes, electrical ratings, terminations and any other design features not listed in this catalog TEMPCO will custom manufacture to your specifications. Consult us with your requirements.

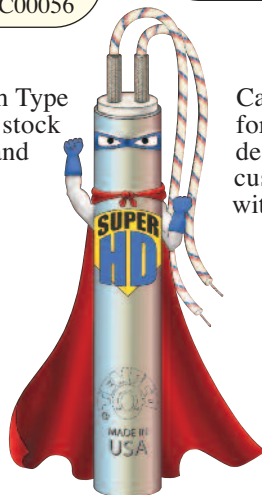



STOCK — Immediate Delivery through the TERMINATOR[®] Lead Conversion Program

5/16" Actual .308" (7.82 mm) Diameter Hi-Density Cartridge Heaters

Part Numbers listed are for stock Cartridge Heaters terminated with 10 inch long leads (Type N Termination).

Other Terminator Program terminations and options can also be applied to stock heaters (see Ordering Information).

Sheath Length in mm	Watts	Watt Density		Part Number		
		W/in ²	W/cm ²	120V	240V	
2	50.8	150	102	16	HDC00108	—
2½	63.5	150	76	12	HDC00109	—
2½	63.5	200	102	16	HDC00110	HDC00111
3	76.2	225	92	14	HDC00112	HDC00113
3¾	85.7	160	57	9	HDC00114	—
3½	88.9	250	85	13	HDC00115	—

Sheath Length in mm	Watts	Watt Density		Part Number		
		W/in ²	W/cm ²	120V	240V	
4	101.6	275	80	12	HDC00117	HDC00118
5	127.0	350	79	12	HDC00119	HDC00120
5½	139.7	250	51	8	HDC00121	—
6	152.4	450	83	13	HDC00122	HDC00123
7½	190.5	600	87	14	—	HDC00124

3/8" Actual .371" (9.42 mm) Diameter Hi-Density Cartridge Heaters

Part Numbers listed are for stock Cartridge Heaters terminated with 10 inch long leads (Type N Termination).

Other Terminator Program terminations and options can also be applied to stock heaters (see Ordering Information).

Sheath Length in mm	Watts	Watt Density		Part Number		
		W/in ²	W/cm ²	120V	240V	
1	25.4	50	85	13	HDC00125	—
1	25.4	100	170	26	HDC00127	—
1	25.4	150	255	40	HDC00128	HDC00129
1	25.4	200	340	53	—	HDC00130
1¼	31.8	100	113	18	HDC00133	—
1¼	31.8	150	170	26	HDC00135	HDC00136
1¼	31.8	200	226	35	HDC00137	HDC00138
1½	33.3	100	104	16	HDC00139	HDC00140
1½	33.3	150	157	24	HDC00141	—
1½	34.9	150	146	23	HDC00142	HDC00143
1½	36.5	100	91	14	HDC00144	—
1½	38.1	30	25	4	HDC00146	—
1½	38.1	50	42	7	HDC00147	HDC00148
1½	38.1	75	64	10	HDC00149	—
1½	38.1	100	85	13	HDC00150	HDC00151
1½	38.1	125	106	17	—	HDC00152
1½	38.1	150	127	20	HDC00153	HDC00154
1½	38.1	200	170	26	HDC00155	HDC00156
1½	38.1	250	212	33	HDC00157	HDC00158
1¾	44.5	150	102	16	HDC00160	HDC00161
1¾	44.5	200	136	21	—	HDC00163
1¾	44.5	250	170	26	HDC00164	HDC00165
1¾	46.0	150	97	15	—	HDC00166
1¾	46.0	200	129	20	HDC00167	—
1¾	47.6	250	154	24	HDC00169	—
2	50.8	50	28	4	HDC00170	—
2	50.8	75	42	7	HDC00171	—
2	50.8	100	57	9	HDC00172	HDC00173
2	50.8	125	71	11	HDC00174	—
2	50.8	150	85	13	HDC00175	HDC00176
2	50.8	200	113	18	HDC00177	HDC00178
2	50.8	250	141	22	HDC00179	HDC00180
2	50.8	300	170	26	HDC00181	HDC00182
2	50.8	350	198	31	—	HDC00183
2	50.8	400	226	35	HDC00184	HDC00185
2	50.8	500	283	44	HDC00186	HDC00187
2¼	57.2	75	36	6	HDC00189	—
2¼	57.2	100	49	8	HDC00190	—
2¼	57.2	125	61	9	HDC00191	HDC00192
2¼	57.2	150	73	11	—	HDC00193
2¼	57.2	175	85	13	HDC00194	—
2¼	57.2	200	97	15	—	HDC00196
2¼	57.2	250	125	19	HDC00197	—
2¼	57.2	300	146	23	HDC00199	HDC00200

Sheath Length in mm	Watts	Watt Density		Part Number		
		W/in ²	W/cm ²	120V	240V	
2¼	57.2	350	170	26	HDC00201	HDC00202
2¼	57.2	400	194	30	—	HDC00204
2¼	57.2	500	243	38	—	HDC00205
2½	60.3	75	34	5	HDC00206	—
2½	60.3	165	75	12	—	HDC00207
2½	60.3	300	136	21	—	HDC00210
2½	63.5	100	42	7	HDC00213	HDC00214
2½	63.5	125	53	8	HDC00215	—
2½	63.5	150	64	10	—	HDC00216
2½	63.5	200	85	13	HDC00217	HDC00218
2½	63.5	250	106	17	HDC00219	HDC00220
2½	63.5	300	127	20	HDC00221	HDC00222
2½	63.5	350	149	23	—	HDC00223
2½	63.5	400	174	27	HDC00224	—
2½	63.5	500	212	33	HDC00227	HDC00228
2¾	69.9	400	151	23	—	HDC00231
2¾	71.4	300	110	17	—	HDC00235
3	76.2	100	34	5	HDC00236	HDC00237
3	76.2	125	42	7	HDC00238	—
3	76.2	150	51	8	HDC00239	—
3	76.2	200	68	11	HDC00240	HDC00241
3	76.2	250	85	13	HDC00242	HDC00243
3	76.2	300	102	16	HDC00244	HDC00245
3	76.2	375	127	20	HDC00247	—
3	76.2	400	136	21	HDC00249	HDC00250
3	76.2	500	170	26	HDC00251	HDC00252
3	76.2	600	204	32	—	HDC00253
3	76.2	750	255	40	—	HDC00254
3¾	84.1	500	151	23	HDC00255	—
3½	88.9	125	35	6	HDC00256	—
3½	88.9	200	57	9	—	HDC00257
3½	88.9	225	64	10	—	HDC00258
3½	88.9	250	71	11	HDC00259	HDC00260
3½	88.9	300	85	13	HDC00261	HDC00262
3½	88.9	350	99	15	HDC00263	HDC00264
3½	88.9	400	113	18	—	HDC00265
3½	88.9	500	141	22	HDC00266	HDC00267
3¾	96.8	150	38	6	HDC00269	—
3¾	96.8	500	128	20	—	HDC00270
4	101.6	100	24	4	HDC00272	—
4	101.6	125	30	5	HDC00273	HDC00274
4	101.6	150	36	6	HDC00275	—
4	101.6	175	42	7	HDC00276	—
4	101.6	200	49	8	HDC00277	HDC00278

Cartridge Heaters



Hi-Density

STOCK — Immediate Delivery through the TERMINATOR Lead Conversion Program

Continued from previous page...



3/8" Actual .371" (9.42 mm) Diameter Hi-Density Cartridge Heaters

Part Numbers listed are for stock Cartridge Heaters terminated with 10 inch long leads (Type N Termination). Other Terminator Program terminations and options can also be applied to stock heaters (see Ordering Information).

Sheath Length in	mm	Watts	Watt Density		Part Number	
			W/in ²	W/cm ²	120V	240V
4	101.6	250	61	9	HDC00279	HDC00280
4	101.6	300	73	11	HDC00281	HDC00282
4	101.6	350	85	13	HDC00283	HDC00284
4	101.6	400	97	15	HDC00285	HDC00286
4	101.6	450	109	17	—	HDC00288
4	101.6	500	121	19	HDC00289	HDC00290
4	101.6	600	146	23	—	HDC00292
4	101.6	700	170	26	—	HDC00293
4	101.6	750	182	28	—	HDC00294
4 1/4	108.0	300	68	11	—	HDC00295
4 1/4	108.0	750	170	26	—	HDC00296
4 1/2	114.3	250	53	8	—	HDC00297
4 1/2	114.3	300	64	10	HDC00298	HDC00299
4 1/2	114.3	450	95	15	HDC00302	HDC00303
4 1/2	114.3	500	106	17	HDC00304	HDC00305
4 3/4	120.7	300	60	9	—	HDC00307
4 3/16	122.2	300	59	9	—	HDC00308
4 3/16	122.2	500	98	15	—	HDC00309
5	127.0	150	28	4	HDC00312	HDC00313
5	127.0	200	38	6	HDC00314	HDC00315
5	127.0	250	47	7	HDC00316	—
5	127.0	300	57	9	HDC00317	HDC00318
5	127.0	350	66	10	—	HDC00319
5	127.0	400	75	12	HDC00320	HDC00321
5	127.0	500	94	15	HDC00323	HDC00324
5	127.0	600	113	18	—	HDC00327
5	127.0	700	132	21	—	HDC00328
5	127.0	750	141	22	—	HDC00329
5	127.0	800	151	23	—	HDC00330
5	127.0	1000	189	29	—	HDC00331
5 1/4	133.3	200	36	6	—	HDC00332
5 1/2	139.7	250	42	7	HDC00334	HDC00335
5 1/2	139.7	550	93	15	—	HDC00338
5 1/2	139.7	600	102	16	—	HDC00339
5 1/2	139.7	1000	170	26	—	HDC00340
5 3/4	146.1	400	65	10	—	HDC00341
5 3/4	146.1	600	97	15	HDC00342	HDC00343
6	152.4	200	31	5	HDC00344	—
6	152.4	250	39	6	HDC00345	HDC00346
6	152.4	300	46	7	HDC00347	HDC00348
6	152.4	400	62	10	HDC00349	HDC00350
6	152.4	500	77	12	HDC00351	HDC00352
6	152.4	600	93	14	HDC00353	HDC00354
6	152.4	675	104	16	—	HDC00355
6	152.4	750	116	18	HDC00356	HDC00357
6	152.4	800	123	19	—	HDC00358
6	152.4	900	139	22	—	HDC00359
6	152.4	1000	154	24	—	HDC00360
6 1/2	165.1	600	85	13	—	HDC00361
6 1/2	165.1	1000	141	22	—	HDC00362
7	177.8	250	33	5	HDC00365	HDC00366
7	177.8	350	46	7	—	HDC00367

Sheath Length in	mm	Watts	Watt Density		Part Number	
			W/in ²	W/cm ²	120V	240V
7	177.8	400	52	8	HDC00368	—
7	177.8	500	65	10	—	HDC00369
7	177.8	600	78	12	HDC00370	HDC00371
7	177.8	750	98	15	—	HDC00373
7	177.8	775	101	16	—	HDC00374
7	177.8	1000	131	20	—	HDC00375
7 1/2	190.5	600	73	11	—	HDC00377
7 1/2	190.5	725	88	14	—	HDC00378
7 1/2	190.5	850	103	16	—	HDC00379
7 1/2	190.5	1000	121	19	—	HDC00380
7 3/16	198.4	750	87	14	—	HDC00381
8	203.2	250	30	5	HDC07944	—
8	203.2	300	34	5	HDC00382	HDC00383
8	203.2	400	45	7	HDC00384	—
8	203.2	450	51	8	HDC00385	—
8	203.2	500	57	9	HDC00386	HDC00387
8	203.2	600	68	11	HDC00388	HDC00389
8	203.2	700	79	12	—	HDC00390
8	203.2	750	85	13	—	HDC00391
8	203.2	900	102	16	—	HDC00392
8	203.2	1000	113	18	—	HDC00393
8 3/8	219.1	500	52	8	—	HDC00395
9	228.6	200	20	3	HDC00396	HDC00397
9	228.6	500	50	8	—	HDC00398
9	228.6	885	88	14	—	HDC00399
9	228.6	1000	100	16	—	HDC00400
9 1/2	241.3	200	19	3	HDC00401	—
9 1/2	241.3	600	57	9	—	HDC00402
9 1/2	241.3	1000	94	15	—	HDC00403
10	254.0	400	36	5	HDC00405	—
10	254.0	500	45	7	—	HDC00407
10	254.0	600	54	8	HDC00408	HDC00409
10	254.0	700	63	10	—	HDC00410
10	254.0	750	67	10	—	HDC00411
10	254.0	1000	89	14	—	HDC00413
10	254.0	1500	134	21	—	HDC00415
10 3/16	274.6	375	31	5	—	HDC00416
12	304.8	400	30	5	HDC00417	—
12	304.8	500	37	6	—	HDC00418
12	304.8	600	44	7	HDC00419	HDC00420
12	304.8	750	57	9	—	HDC14222
12	304.8	1000	74	11	—	HDC00421
12	304.8	1500	113	18	—	HDC06225
12 1/16	325.4	1000	69	11	—	HDC00422
13	330.2	1000	70	11	—	HDC07200
14	355.6	600	39	6	—	HDC22941
14	355.6	750	47	7	—	HDC00423
16	406.4	600	34	5	—	HDC22942
16	406.4	1200	66	10	—	HDC00424
18	457.2	1000	58	9	—	HDC22943
20	508.0	1000	53	8	—	HDC09305
24	609.6	1000	38	6	—	HDC10234

Ordering Information

Order by Part Number for stock Cartridge heaters with Type N termination. Call Tempco for part numbers for stock heaters with other Terminator Program terminations and options (see pages 2-12 & 2-13).

Custom Engineered/Manufactured

Cartridge Heaters can be application specific; therefore for sizes, electrical ratings, terminations and any other design features not listed in this catalog **TEMPCO** will custom manufacture to your specifications. Consult us with your requirements.



STOCK — Immediate Delivery through the **TERMINATOR** Lead Conversion Program

1/2" Actual .496" (12.60 mm) Diameter Hi-Density Cartridge Heaters

Part Numbers listed are for stock Cartridge Heaters terminated with 10 inch long leads (Type N Termination).

Other Terminator Program terminations and options can also be applied to stock heaters (see Ordering Information).

Sheath Length		Watts	Watt Density		Part Number	
in	mm		W/in ²	W/cm ²	120V	240V
1	25.4	50	64	10	HDC00426	—
1	25.4	150	191	30	HDC00427	—
1	25.4	200	255	40	—	HDC00428
1¼	31.8	50	42	7	HDC00429	—
1¼	31.8	125	106	17	HDC00430	HDC00431
1¼	31.8	180	153	24	—	HDC00432
1¼	31.8	200	170	26	—	HDC00433
1¼	31.8	250	212	33	—	HDC00434
1½	38.1	50	32	5	HDC00435	—
1½	38.1	150	95	15	HDC00436	HDC00437
1½	38.1	200	127	20	HDC00438	HDC00439
1½	44.5	100	51	8	HDC00440	—
1¾	44.5	200	102	16	—	HDC00441
1¾	44.5	250	127	20	HDC00442	—
1¾	44.5	400	204	32	—	HDC00443
2	50.8	75	32	5	HDC00444	—
2	50.8	100	52	8	—	HDC22944
2	50.8	150	64	10	HDC00445	—
2	50.8	175	74	12	HDC00446	—
2	50.8	200	85	13	HDC00447	HDC00448
2	50.8	250	106	17	HDC00449	HDC00450
2	50.8	300	127	20	HDC00451	HDC00452
2	50.8	400	170	26	HDC00453	HDC00454
2	50.8	500	212	33	HDC00455	—
2	50.8	600	255	40	—	HDC00456
2	50.8	700	297	46	—	HDC00457
2¼	57.2	75	27	4	HDC00458	—
2¼	57.2	100	36	6	HDC00459	—
2¼	57.2	125	45	7	HDC00460	—
2¼	57.2	150	55	9	HDC00461	—
2¼	57.2	250	91	14	HDC00462	HDC00463
2¼	57.2	300	109	17	—	HDC00464
2¼	57.2	400	146	23	HDC00465	HDC00466
2¼	57.2	500	182	28	HDC00467	HDC00468
2½	60.3	100	34	5	HDC00470	HDC00471
2½	60.3	125	42	7	HDC00472	—
2½	60.3	250	85	13	HDC00473	HDC00474
2½	60.3	400	136	21	—	HDC00475
2½	60.3	500	170	26	HDC00476	HDC00477
2½	63.5	100	32	5	HDC00478	HDC00479
2½	63.5	125	40	6	HDC00480	—
2½	63.5	150	48	7	—	HDC00481
2½	63.5	200	64	10	HDC00482	HDC00483
2½	63.5	250	80	12	HDC00484	HDC00485
2½	63.5	300	95	15	HDC00486	HDC00487
2½	63.5	400	127	20	HDC00489	HDC00490
2½	63.5	500	159	25	HDC00491	HDC00492
2½	65.1	300	93	14	—	HDC00493
2¾	65.1	350	108	17	HDC00494	—
2¾	69.9	250	71	11	HDC00495	—
2¾	69.9	400	113	18	HDC00496	HDC00497
3	76.2	125	32	5	HDC00498	HDC00499
3	76.2	150	38	6	HDC00500	HDC00501
3	76.2	200	51	8	—	HDC00502
3	76.2	250	64	10	HDC00503	HDC00504
3	76.2	300	76	12	HDC00505	HDC00506
3	76.2	350	89	14	HDC00507	—
3	76.2	400	102	16	HDC00508	HDC00509

Sheath Length		Watts	Watt Density		Part Number	
in	mm		W/in ²	W/cm ²	120V	240V
3	76.2	500	127	20	HDC00510	HDC00511
3	76.2	600	153	24	HDC00512	HDC00513
3	76.2	750	191	30	HDC00514	HDC00515
3	76.2	1000	255	40	HDC00516	—
3½	88.9	250	53	8	HDC00517	HDC00518
3½	88.9	300	64	10	—	HDC00519
3½	88.9	350	74	12	—	HDC00520
3½	88.9	400	95	15	—	HDC08472
3½	88.9	500	106	17	HDC00522	HDC00523
3½	88.9	750	159	25	—	HDC00524
3½	88.9	1000	212	33	—	HDC00525
3¾	95.3	500	98	15	—	HDC00526
3⅞	96.8	250	48	8	—	HDC00527
3⅞	96.8	500	96	15	HDC00528	—
4	101.6	150	27	4	HDC00529	HDC00530
4	101.6	200	40	6	—	HDC07555
4	101.6	250	45	7	HDC00531	HDC00532
4	101.6	300	55	9	HDC00533	HDC00534
4	101.6	350	64	10	HDC00536	HDC00537
4	101.6	400	73	11	HDC00538	HDC00539
4	101.6	500	91	14	HDC00540	HDC00541
4	101.6	550	100	16	HDC00542	HDC00543
4	101.6	600	109	17	—	HDC00544
4	101.6	750	136	21	HDC00545	HDC00546
4	101.6	1000	182	28	—	HDC00547
4	101.6	1200	218	34	—	HDC00548
4½	109.5	550	92	14	HDC00550	—
4½	114.3	250	40	6	HDC00551	—
4½	114.3	350	56	9	—	HDC00552
4½	114.3	500	80	12	HDC00553	HDC00554
4½	114.3	650	103	16	HDC00555	HDC00556
4½	114.3	750	119	19	HDC00557	HDC00558
4½	114.3	1000	159	25	—	HDC00559
4¾	120.7	200	30	5	—	HDC00560
4⅞	122.2	250	37	6	HDC00561	—
4⅞	122.2	300	44	7	—	HDC00562
4⅞	122.2	1000	148	23	—	HDC00563
5	127.0	200	28	4	HDC00565	HDC00566
5	127.0	250	35	6	HDC00567	—
5	127.0	300	42	7	—	HDC00568
5	127.0	350	50	8	HDC00569	HDC00570
5	127.0	400	57	9	HDC00571	HDC00572
5	127.0	500	71	11	HDC00573	HDC00574
5	127.0	550	78	12	—	HDC00575
5	127.0	600	85	13	—	HDC00576
5	127.0	625	88	14	—	HDC00577
5	127.0	750	106	17	HDC00578	HDC00579
5	127.0	800	113	18	—	HDC00580
5	127.0	1000	141	22	—	HDC00581
5¼	133.4	250	34	5	HDC00582	HDC00583
5¼	133.4	1000	134	21	—	HDC00584
5½	139.7	200	25	4	—	HDC00585
5½	139.7	500	64	10	HDC00586	HDC00587
5½	139.7	650	83	13	—	HDC00588
5½	139.7	750	95	15	HDC00589	HDC00590
5¾	146.1	350	42	7	—	HDC00591
5¾	146.1	700	85	13	HDC00592	HDC00593
5⅞	147.6	300	36	6	—	HDC00594

Cartridge Heaters



Hi-Density

STOCK — Immediate Delivery through the **TERMINATOR** Lead Conversion Program



Continued from previous page...

1/2" Actual .496" (12.60 mm) Diameter Hi-Density Cartridge Heaters

Part Numbers listed are for stock Cartridge Heaters terminated with 10 inch long leads (Type N Termination). Other Terminator Program terminations and options can also be applied to stock heaters (see Ordering Information).

Sheath Length		Watts	Watt Density		Part Number	
in	mm		W/in ²	W/cm ²	120V	240V
6	152.4	200	23	4	—	HDC00595
6	152.4	250	29	5	HDC00596	HDC00597
6	152.4	300	35	5	HDC00598	HDC00599
6	152.4	350	41	6	HDC00600	HDC00601
6	152.4	450	52	8	—	HDC00602
6	152.4	500	58	9	HDC00603	HDC00604
6	152.4	600	69	11	—	HDC00605
6	152.4	750	87	14	HDC00606	HDC00607
6	152.4	850	98	15	HDC00609	HDC00610
6	152.4	875	101	16	—	HDC00611
6	152.4	1000	116	18	HDC00612	HDC00613
6	152.4	1200	139	22	—	HDC00614
6	152.4	1500	183	28	—	HDC16228
6 3/8	161.9	1000	108	17	—	HDC00615
6 1/2	165.1	500	53	8	HDC00616	HDC00617
6 1/2	165.1	1000	106	17	—	HDC00618
6 3/4	171.5	500	51	8	HDC00619	HDC00620
7	177.8	250	24	4	HDC00621	—
7	177.8	340	33	5	—	HDC00622
7	177.8	400	39	6	—	HDC00623
7	177.8	500	49	8	HDC00624	HDC00625
7	177.8	600	59	9	HDC00626	HDC00627
7	177.8	700	69	11	—	HDC00628
7	177.8	750	73	11	HDC00629	HDC00630
7	177.8	1000	98	15	HDC00631	HDC00632
7	177.8	1500	147	23	—	HDC00633
7 1/2	190.5	500	45	7	HDC00634	HDC00635
7 1/2	190.5	1000	91	14	—	HDC00636
7 3/4	196.9	1000	88	14	—	HDC00637
8	203.2	200	17	3	—	HDC00639
8	203.2	300	25	4	HDC00640	HDC00641
8	203.2	500	42	7	HDC00642	HDC00643
8	203.2	600	51	8	—	HDC00644
8	203.2	750	64	10	HDC00645	HDC00646
8	203.2	800	68	11	HDC00647	HDC00648
8	203.2	1000	85	13	HDC00650	HDC00651
8	203.2	1200	102	16	—	HDC00653
8	203.2	1500	127	20	—	HDC00654
8	203.2	2000	170	26	—	HDC00655
8 1/2	215.9	300	24	4	—	HDC00656
8 1/2	215.9	500	40	6	—	HDC00657
8 1/2	215.9	1000	80	12	HDC00658	HDC00659
8 3/4	222.3	1000	77	12	—	HDC00660
9	228.6	500	37	6	—	HDC00661
9	228.6	750	56	9	—	HDC00662
9	228.6	1000	75	12	HDC00663	HDC00664

Sheath Length		Watts	Watt Density		Part Number	
in	mm		W/in ²	W/cm ²	120V	240V
9	228.6	1325	99	15	—	HDC00665
9	228.6	1500	112	17	—	HDC00666
9 1/2	241.3	500	35	6	—	HDC00667
9 1/2	241.3	800	57	9	—	HDC00668
9 1/2	241.3	1000	71	11	—	HDC00669
10	254.0	500	34	5	HDC00670	HDC00671
10	254.0	750	50	8	—	HDC00672
10	254.0	800	54	8	—	HDC00673
10	254.0	1000	67	10	HDC00674	HDC00675
10	254.0	1250	84	13	—	HDC00677
10	254.0	1500	101	16	—	HDC00678
10	254.0	2000	134	21	—	HDC00679
10 1/2	266.7	1500	95	15	—	HDC00680
11	279.4	500	30	5	HDC00681	—
11	279.4	1000	61	9	—	HDC00682
11	279.4	1500	91	14	—	HDC00683
11	279.4	2000	121	19	—	HDC00684
11 1/2	292.1	1525	88	14	—	HDC00685
12	304.8	500	28	4	HDC00686	HDC00687
12	304.8	600	33	5	HDC00688	HDC00689
12	304.8	1000	55	9	HDC00690	HDC00691
12	304.8	1100	61	9	—	HDC00692
12	304.8	1500	83	13	—	HDC00693
12	304.8	2000	111	17	—	HDC00694
12 1/2	317.5	1675	89	14	—	HDC00695
13 1/2	342.9	500	24	4	—	HDC00696
14	355.6	1000	47	7	—	HDC00697
14	355.6	1700	80	12	—	HDC00698
14	355.6	2300	108	17	—	HDC00699
15	381.0	800	35	5	—	HDC00700
15	381.0	1000	44	7	—	HDC00701
15	381.0	1500	66	10	—	HDC00702
15	381.0	2000	88	14	—	HDC00703
16	406.4	800	33	5	—	HDC00704
16	406.4	1000	41	6	—	HDC00705
16	406.4	2000	84	13	—	HDC17207
16 1/2	419.1	2200	88	14	—	HDC00706
17	431.8	1000	39	6	—	HDC00707
18	457.2	750	27	4	—	HDC00708
18	457.2	1000	36	6	—	HDC00709
18	457.2	1500	55	9	—	HDC00710
18	457.2	1700	62	10	—	HDC00711
18	457.2	2000	73	11	—	HDC00712
20	508.0	1000	34	5	—	HDC11652
24	609.6	1000	28	4	—	HDC14867

Ordering Information

Order by Part Number for stock Cartridge heaters with Type N termination. Call Tempco for part numbers for stock heaters with other Terminator Program terminations and options (see pages 2-12 & 2-13).

Custom Engineered/Manufactured

Cartridge Heaters can be application specific; therefore for sizes, electrical ratings, terminations and any other design features not listed in this catalog **TEMPCO** will custom manufacture to your specifications. Consult us with your requirements.



STOCK — Immediate Delivery through the **TERMINATOR** Lead Conversion Program

5/8" Actual .621" (15.77 mm) Diameter Hi-Density Cartridge Heaters

Part Numbers listed are for stock Cartridge Heaters terminated with 10 inch long leads (Type N Termination). Other Terminator Program terminations and options can also be applied to stock heaters (see Ordering Information).

Sheath Length		Watts	Watt Density		Part Number	
in	mm		W/in ²	W/cm ²	120V	240V
1¼	31.8	50	34	5	HDC00713	—
1¼	31.8	200	136	21	HDC00714	HDC00715
1¼	31.8	250	170	26	HDC00716	HDC00717
1½	38.1	250	127	20	HDC00719	HDC00720
2	50.8	100	34	5	HDC00721	—
2	50.8	125	42	7	HDC00722	—
2	50.8	200	68	11	HDC00723	HDC00724
2	50.8	250	85	13	HDC00725	HDC00726
2	50.8	300	102	16	—	HDC00727
2	50.8	400	136	21	—	HDC00728
2	50.8	500	170	26	—	HDC00729
2	50.8	750	255	40	—	HDC00730
2¼	57.2	100	29	5	HDC00731	—
2¼	57.2	125	36	6	HDC00732	—
2¼	57.2	250	73	11	HDC00733	HDC00734
2¼	57.2	350	102	16	HDC00735	HDC00736
2½	60.3	280	76	12	HDC00739	HDC00740
2½	63.5	180	46	7	HDC00742	—
2½	63.5	275	70	11	HDC00743	HDC00744
2½	63.5	400	102	16	HDC00745	HDC00746
2½	63.5	720	183	28	—	HDC00747
3	76.2	150	31	5	HDC00748	—
3	76.2	180	37	6	HDC00749	—
3	76.2	250	51	8	HDC00750	HDC00751
3	76.2	350	71	11	HDC00752	HDC00753
3	76.2	400	81	13	HDC00754	—
3	76.2	500	102	16	HDC00755	HDC00756
3	76.2	600	122	19	—	HDC00757
3	76.2	720	147	23	—	HDC00758
3	76.2	750	153	24	—	HDC00759
3¼	82.6	200	37	6	HDC00760	—
3¼	82.6	800	148	23	—	HDC00761
3½	88.9	525	89	14	—	HDC00762
3¾	95.3	525	82	13	HDC00763	HDC00764
4	101.6	250	36	6	HDC00766	HDC00767
4	101.6	300	44	7	—	HDC00768
4	101.6	350	51	8	HDC00769	—
4	101.6	400	58	9	—	HDC00770
4	101.6	500	73	11	HDC00771	HDC00772
4	101.6	550	80	12	—	HDC00773
4	101.6	600	87	14	—	HDC00774
4	101.6	750	109	17	HDC00775	HDC00776
4	101.6	1000	146	23	—	HDC00777
4½	114.3	500	64	10	—	HDC00780
4½	114.3	750	95	15	HDC00783	HDC00784
4½	114.3	1000	127	20	—	HDC00785
4¾	120.7	750	90	14	—	HDC00787
5	127.0	250	28	4	HDC00788	HDC00789
5	127.0	500	57	9	—	HDC00790
5	127.0	750	85	13	HDC00791	HDC00792
5	127.0	875	99	15	—	HDC00793
5	127.0	1000	113	18	HDC00794	HDC00795
5¾	136.5	800	84	13	HDC00796	HDC00797
5½	139.7	800	81	13	—	HDC00800
5¾	146.1	500	49	8	—	HDC00801
5¾	146.1	1500	146	23	—	HDC00802

Sheath Length		Watts	Watt Density		Part Number	
in	mm		W/in ²	W/cm ²	120V	240V
6	152.4	300	28	4	HDC00804	HDC00805
6	152.4	500	46	7	HDC00806	HDC00807
6	152.4	750	69	11	—	HDC00808
6	152.4	1000	93	14	HDC00809	HDC00810
6	152.4	1200	111	17	—	HDC00811
6	152.4	1500	139	22	HDC00812	HDC00813
6½	165.1	350	30	5	HDC00814	HDC00815
6½	165.1	500	42	7	HDC00816	HDC00817
6½	165.1	900	76	12	—	HDC00818
6½	165.1	1400	119	18	—	HDC00819
6¾	171.5	500	41	6	—	HDC00820
6¾	171.5	1000	81	13	—	HDC00821
7	177.8	500	39	6	HDC00822	HDC00823
7	177.8	750	59	9	—	HDC00824
7	177.8	1000	78	12	HDC00825	HDC00826
7	177.8	1500	118	18	—	HDC00827
7½	190.5	325	24	4	HDC00828	—
7½	190.5	1300	95	15	—	HDC00829
7¾	196.9	400	28	4	—	HDC00830
7¾	196.9	1000	70	11	—	HDC00831
8	203.2	400	27	4	—	HDC00832
8	203.2	500	34	5	HDC00833	HDC00834
8	203.2	750	51	8	—	HDC00835
8	203.2	850	58	9	—	HDC00836
8	203.2	1000	68	11	HDC00837	HDC00838
8	203.2	1200	81	13	HDC00839	HDC00840
8	203.2	1500	102	16	HDC00841	HDC00842
8	203.2	2000	136	21	—	HDC00843
8¾	222.3	450	28	4	HDC00845	—
8¾	222.3	1800	111	17	—	HDC00846
9	228.6	500	30	5	—	HDC00847
9	228.6	750	45	7	—	HDC00848
9	228.6	1000	60	9	—	HDC00849
9	228.6	1500	90	14	—	HDC00850
9½	241.3	975	55	9	—	HDC00851
10	254.0	500	27	4	HDC00852	HDC00853
10	254.0	650	35	5	HDC00855	—
10	254.0	750	40	6	—	HDC00856
10	254.0	800	43	7	—	HDC00857
10	254.0	1000	54	8	HDC00858	HDC00859
10	254.0	1500	80	13	HDC00860	HDC00861
10	254.0	2000	107	17	—	HDC00862
11	279.4	1000	49	8	—	HDC00863
11	279.4	1400	68	11	—	HDC00864
11	279.4	2000	97	15	—	HDC00865
12	304.8	500	22	3	HDC00866	HDC00867
12	304.8	600	27	4	HDC00868	—
12	304.8	775	34	5	—	HDC00869
12	304.8	900	40	6	—	HDC00870
12	304.8	1000	44	7	HDC00871	HDC00872
12	304.8	1500	66	10	HDC00873	HDC00874
12	304.8	2000	89	14	—	HDC00875
13	330.2	1000	41	6	—	HDC00876
13	330.2	1500	61	10	—	HDC00877
14	355.6	925	35	5	HDC00878	—
14	355.6	1000	38	6	—	HDC00879

Cartridge Heaters



Hi-Density

STOCK — Immediate Delivery through the TERMINATOR[®] Lead Conversion Program



Continued from previous page...

5/8" Actual .621" (15.77 mm) Diameter Hi-Density Cartridge Heaters

Part Numbers listed are for stock Cartridge Heaters terminated with 10 inch long leads (Type N Termination). Other Terminator Program terminations and options can also be applied to stock heaters (see Ordering Information).

Sheath Length		Watts	Watt Density		Part Number	
in	mm		W/in ²	W/cm ²	120V	240V
14	355.6	1500	57	9	—	HDC00880
14	355.6	3700	140	22	—	HDC00881
15	381.0	750	26	4	—	HDC00882
15	381.0	1000	35	5	—	HDC00883
15	381.0	2400	84	13	—	HDC00884
15	381.0	4000	140	22	—	HDC00885
16	406.4	1000	33	5	—	HDC00886
16	406.4	2500	82	13	—	HDC00887
16	406.4	4500	148	23	—	HDC00888
17	431.8	1000	31	5	—	HDC00889
18	457.2	900	26	4	—	HDC00890
18	457.2	1000	29	5	—	HDC00891
18	457.2	1500	44	7	—	HDC00892

Sheath Length		Watts	Watt Density		Part Number	
in	mm		W/in ²	W/cm ²	120V	240V
18	457.2	3000	87	14	—	HDC00893
18	457.2	4700	137	21	—	HDC00894
19	482.6	1000	28	4	—	HDC00895
20	508.0	1000	26	4	—	HDC00896
20	508.0	1500	39	6	—	HDC00897
20	508.0	3500	91	14	—	HDC00898
20	508.0	4700	123	19	—	HDC00899
24	609.6	1000	22	3	—	HDC00900
24	609.6	2000	43	7	—	HDC00901
24	609.6	4700	102	16	—	HDC00902
25¼	641.4	1500	31	5	—	HDC00903
30	762.0	2800	48	8	—	HDC00904
36	914.4	3000	43	7	—	HDC00905

3/4" Actual .746" (18.95 mm) Diameter Hi-Density Cartridge Heaters

Part Numbers listed are for stock Cartridge Heaters terminated with 10 inch long leads (Type N Termination). Other Terminator Program terminations and options can also be applied to stock heaters (see Ordering Information).

Sheath Length		Watts	Watt Density		Part Number	
in	mm		W/in ²	W/cm ²	120V	240V
2	50.8	200	57	9	HDC00906	—
2	50.8	800	226	35	—	HDC00907
2¼	57.2	200	49	8	HDC00908	—
2¼	57.2	800	194	30	—	HDC00909
3	76.2	250	42	7	HDC00910	—
3	76.2	500	85	13	HDC00911	HDC00912
3	76.2	600	102	16	HDC00913	HDC00914
3	76.2	1000	170	26	—	HDC00915
3½	88.9	250	35	6	HDC00916	HDC00917
3½	88.9	350	50	8	—	HDC00918
3½	88.9	500	71	11	HDC00919	—
3½	88.9	1000	141	22	—	HDC00920
3¾	95.3	250	33	5	HDC00921	—
3¾	95.3	500	65	10	—	HDC00922
3¾	95.3	1000	131	20	—	HDC00923
4	101.6	250	30	5	HDC00924	—
4	101.6	500	61	9	HDC00926	HDC00927
4	101.6	750	91	14	—	HDC00928
4	101.6	1000	121	19	HDC00929	HDC00930
4½	114.3	350	37	6	HDC00931	—
4½	114.3	875	93	14	HDC00932	HDC00933
4½	114.3	1400	149	23	—	HDC00934
4¾	120.7	750	75	12	—	HDC00935
5	127.0	300	28	4	HDC00936	HDC00937

Sheath Length		Watts	Watt Density		Part Number	
in	mm		W/in ²	W/cm ²	120V	240V
5	127.0	500	47	7	—	HDC00938
5	127.0	750	71	11	—	HDC00939
5	127.0	1000	94	15	HDC00940	HDC00941
5	127.0	1200	113	18	—	HDC00942
5¼	146.1	1000	81	13	—	HDC00943
6	152.4	500	39	6	HDC00944	HDC00945
6	152.4	750	58	9	—	HDC00946
6	152.4	1000	77	12	HDC00947	HDC00948
6	152.4	1200	93	14	—	HDC00949
6	152.4	1500	116	18	—	HDC00950
6	152.4	2000	154	24	—	HDC00951
7	177.8	500	33	5	HDC00952	HDC00953
7	177.8	1000	65	10	HDC00954	HDC00955
7	177.8	1500	98	15	HDC00956	HDC00957
7	177.8	2000	131	20	—	HDC00958
7¾	193.7	450	27	4	—	HDC00959
8	203.2	350	20	3	—	HDC00961
8	203.2	500	28	4	HDC00962	HDC00963
8	203.2	700	40	6	—	HDC00964
8	203.2	1000	57	9	—	HDC00965
8	203.2	1350	76	12	—	HDC00966
8	203.2	2000	113	18	HDC00967	HDC00968
9	228.6	350	17	3	—	HDC00969
9	228.6	500	25	4	—	HDC00970

Ordering Information

Order by Part Number for stock Cartridge heaters with Type N termination. Call Tempco for part numbers for stock heaters with other Terminator Program terminations and options (see pages 2-12 & 2-13).

Custom Engineered/Manufactured

Cartridge Heaters can be application specific; therefore for sizes, electrical ratings, terminations and any other design features not listed in this catalog **TEMPCO** will custom manufacture to your specifications. Consult us with your requirements.



STOCK — Immediate Delivery through the TERMINATOR[®] Lead Conversion Program

3/4" Actual .746" (18.95 mm) Diameter Hi-Density Cartridge Heaters

Part Numbers listed are for stock Cartridge Heaters terminated with 10 inch long leads (Type N Termination). Other Terminator Program terminations and options can also be applied to stock heaters (see Ordering Information).

Sheath Length		Watts	Watt Density		Part Number	
in	mm		W/in ²	W/cm ²	120V	240V
9	228.6	1000	53	8	—	HDC22945
9	228.6	1200	60	9	—	HDC00971
9	228.6	1800	90	14	—	HDC00973
9¾	247.7	2000	92	14	—	HDC00974
10	254.0	600	27	4	—	HDC00975
10	254.0	1000	45	7	—	HDC00976
10	254.0	1200	54	8	—	HDC00977
10	254.0	1500	70	11	—	HDC22946
10	254.0	2000	89	14	HDC00978	HDC00979
10½	266.7	550	23	4	—	HDC00980
11	279.4	1000	40	6	—	HDC00981
11¾	298.5	2000	75	12	—	HDC00983
12	304.8	800	30	5	—	HDC00984
12	304.8	1000	37	6	—	HDC00985
12	304.8	1200	44	7	—	HDC00986
12	304.8	1500	55	9	—	HDC00987
12	304.8	2000	74	11	HDC00988	HDC00989
12	304.8	2500	92	14	—	HDC00990
12	304.8	4000	148	23	—	HDC00991
13	330.2	1000	34	5	—	HDC00992
14	355.6	800	25	4	—	HDC00993
14	355.6	1000	31	5	—	HDC00994
14	355.6	1125	35	6	HDC00995	—
14	355.6	1250	39	6	—	HDC00996
14	355.6	1400	44	7	—	HDC00997
14	355.6	2500	79	12	—	HDC00998
14	355.6	4500	141	22	—	HDC00999
14¾	374.7	1500	45	7	—	HDC01000

Sheath Length		Watts	Watt Density		Part Number	
in	mm		W/in ²	W/cm ²	120V	240V
15	381.0	1000	29	5	—	HDC01001
15	381.0	1500	44	7	—	HDC01002
16	406.4	1000	27	4	—	HDC01003
16	406.4	1175	32	5	HDC01004	—
16	406.4	1500	41	6	—	HDC01005
16	406.4	1800	49	8	—	HDC01006
16	406.4	3000	82	13	—	HDC01007
16	406.4	4700	129	20	—	HDC01008
17	431.8	1000	26	4	—	HDC01009
17¾	450.9	850	21	3	—	HDC01010
18	457.2	1000	24	4	—	HDC01011
18	457.2	1250	30	5	HDC01012	—
18	457.2	1450	35	6	—	HDC01013
18	457.2	2000	49	8	—	HDC01014
18	457.2	3250	79	12	—	HDC01015
18	457.2	5000	121	19	—	HDC01016
19	482.6	1000	23	4	—	HDC01017
20	508.0	1000	22	4	—	HDC01018
20	508.0	1150	25	4	—	HDC01019
20	508.0	2050	45	7	—	HDC01020
20	508.0	2250	49	8	—	HDC01021
20	508.0	5250	114	18	—	HDC01022
24	609.6	1000	18	3	—	HDC01023
24	609.6	1375	25	4	—	HDC01024
24	609.6	2000	36	6	—	HDC01025
24	609.6	2750	50	8	—	HDC01026
24	609.6	5500	99	15	—	HDC01027
36	914.4	2500	30	5	—	HDC01028

Ordering Information

Order by Part Number for stock Cartridge heaters with Type N termination. Call Tempco for part numbers for stock heaters with other Terminator Program terminations and options (see pages 2-12 & 2-13).

Custom Engineered/Manufactured

Cartridge Heaters can be application specific; therefore for sizes, electrical ratings, terminations and any other design features not listed in this catalog **TEMPCO** will custom manufacture to your specifications. Consult us with your requirements.

1" Dia. Actual .996" (25.30 mm) Hi-Density Cartridge Heaters with Type N termination 10" leads

Sheath Length		Watts	Watt Density		Part Number	
in	mm		W/in ²	W/cm ²	120V	240V
3	76.2	750	101	16	—	HDC02662
3½	88.9	565	63	10	—	HDC02663
5	127.0	1000	73	11	—	HDC02664
7¾	200.0	500	22	3	HDC02665	HDC02666
8	203.2	1500	65	10	—	HDC02667
8¾	222.3	875	34	5	—	HDC02668
11½	292.1	1000	29	5	HDC02669	—
13	330.2	1000	26	4	HDC02670	—
14	355.6	2700	64	10	—	HDC02671
15	381.0	1000	22	3	HDC02672	—

Sheath Length		Watts	Watt Density		Part Number	
in	mm		W/in ²	W/cm ²	120V	240V
16	406.4	1800	37	6	—	HDC02673
17¾	441.3	2400	46	7	—	HDC02674
20	508.0	1000	16	3	—	HDC02675
20	508.0	2800	46	7	—	HDC02676
25	635.0	1725	23	3	HDC02677	HDC02678
40	1016.0	4400	36	6	—	HDC02679
49	1244.6	3725	25	4	—	HDC02680
50½	1282.7	945	6	1	—	HDC02681
57	1447.8	2800	16	3	—	HDC02682
60	1524.0	1500	8	1	—	HDC02683



Note: 1" Dia. Hi-Density Cartridge Heaters are made-to-order only. Refer to ordering information on page 2-3. **Standard lead time is 3 weeks.**

Cartridge Heaters



Type F Terminated Stock Heaters

STOCK Cartridge Heaters with Type F Flexible Lead Termination

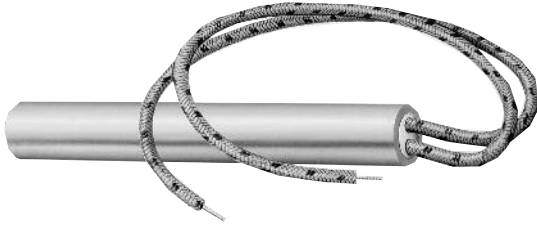

Type F Internally Connected Flexible Leads 10" Long

This lead termination provides flexibility; the lead wires are internally connected to the terminal pins. The lead wires can be sharply bent as they exit the ceramic insulating cap without exposing the bare wire.

1/4" Diameter Actual .246" (6.25 mm)

Sheath Length		Watts	Volts	Watt Density		Part Number
in	mm			W/in ²	W/cm ²	
1	25.4	80	120	204	32	HDC05603
1½	38.1	50	120	64	10	HDC06151
1½	38.1	200	120	255	40	HDC10869
2	50.8	200	240	170	26	HDC01989
2	50.8	250	240	212	33	HDC05179
2	50.8	300	240	255	40	HDC04556
2½	63.5	300	240	191	30	HDC07119
3	76.2	75	120	38	6	HDC10412
3	76.2	300	240	153	24	HDC04490
4	101.6	400	240	146	23	HDC04200
5¼	146.1	350	120	94	15	HDC04732

3/8" Diameter Actual .371" (9.42 mm)

Sheath Length		Watts	Volts	Watt Density		Part Number
in	mm			W/in ²	W/cm ²	
¼	31.8	150	240	170	26	HDC06254
¼	31.8	200	240	226	35	HDC04349
½	31.8	250	120	212	33	HDC04402
2	50.8	250	240	141	22	HDC04291
2	50.8	350	240	198	31	HDC11345
2½	63.5	250	240	106	16	HDC07496
2½	63.5	350	240	149	23	HDC04759
2½	63.5	500	240	212	33	HDC05359
3	76.2	300	240	102	16	HDC02094
3	76.2	375	240	127	20	HDC06779
3½	88.9	350	240	99	15	HDC04861
4	101.6	400	120	97	15	HDC04560
4	101.6	500	240	121	19	HDC04552
5½	139.7	1000	240	170	26	HDC05431
7	177.8	350	240	46	7	HDC05303
12	304.8	1000	240	74	11	HDC05833

1/2" Diameter Actual .496" (12.60 mm)

Sheath Length		Watts	Volts	Watt Density		Part Number
in	mm			W/in ²	W/cm ²	
2	50.8	300	240	127	20	HDC03872
3¼	79.4	500	240	121	19	HDC11162
3¼	96.8	250	240	48	7	HDC10330
4	101.6	500	240	91	14	HDC04676
4	101.6	600	240	109	17	HDC03878
5	127	500	240	71	11	HDC04701
6	152.4	500	240	58	9	HDC04677
6	152.4	750	240	87	14	HDC04352
6	152.4	1000	240	116	18	HDC03887
7	177.8	750	240	73	11	HDC03893
8	203.2	500	240	42	7	HDC02265
8	203.2	1000	240	85	13	HDC02263
10	254	1000	240	67	10	HDC04220

5/8" Diameter Actual .621" (15.77 mm)

Sheath Length		Watts	Volts	Watt Density		Part Number
in	mm			W/in ²	W/cm ²	
3	76.2	750	240	153	24	HDC04483
6	152.4	600	240	56	9	HDC11240
6	152.4	1000	240	93	14	HDC07353

All Items Available from Stock



Note: Custom Engineered/Manufactured Hi-Density Cartridge Heaters with Type F Flexible Lead Termination
Refer to ordering information on page 2-3.



Standard Size Stock Type CM 1/2" & 3/4" NPT Screw Plug Hi-Density Cartridge Immersion Heaters

Hi-Density Cartridge Immersion Heaters are designed for heating water and other liquids. The high watt density capability of this heater permits greater heat dissipation in a given area than would a tubular immersion heater.

However, it is important to note that allowable watt density depends on the material being heated. For water heating, watt densities of several hundred watts per square inch are possible; oil heating may be limited to 5 to 20 watts per square inch.

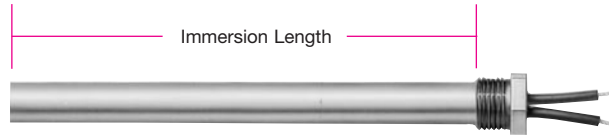

Design Features

- * Passivated Incoloy® Sheath
- * 10" long Teflon® Insulated Lead Wires
- * Brass Fitting
- * Epoxy Seal at Lead End
266°F (130°C) Standard
UL Rating 194°F (90°C)



Note: See pages 2-50 & 2-51 for other fitting options

Diameter	Heater Immersion Length		Watts	Watt Density		Part Number			
	in	mm		W/in ²	W/cm ²	120V	240V	480V	
5/8" Incoloy® Sheath	1½	38.1	100	41	6	HDL00001	—	—	
	1½	38.1	400	163	25	—	HDL00002	—	
	3½	88.9	250	39	6	HDL00003	HDL00004	—	
	3½	88.9	1000	157	24	—	HDL00005	HDL00006	
	1/2 NPT Fitting	7⅞	200.0	500	33	5	HDL00007	HDL00008	—
		7⅞	200.0	2000	134	21	—	HDL00009	HDL00010
12		304.8	750	33	5	HDL00011	HDL00012	—	
12		304.8	3000	130	20	—	HDL00013	HDL00014	
3/4" Incoloy® Sheath	4¼	108.0	500	53	8	HDL00015	HDL00016	—	
	4¼	108.0	750	80	12	HDL00017	HDL00018	—	
	4¼	108.0	1000	106	16	HDL00019	HDL00020	—	
	4¾	117.5	300	29	5	HDL00021	HDL00022	—	
	3/4 NPT Fitting	4¾	117.5	1200	116	18	—	HDL00023	HDL00024
		4¾	120.7	375	35	5	HDL00025	HDL00026	—
		4¾	120.7	1500	141	22	—	HDL00027	HDL00028
		5¼	146.1	500	39	6	HDL00029	HDL00030	—
	3/4 NPT Fitting	5¼	146.1	2000	154	24	—	HDL00031	HDL00032
		6¼	158.8	500	35	5	HDL00033	HDL00034	—
		6¼	158.8	2000	141	22	—	HDL00035	HDL00036
		6½	165.1	625	42	7	HDL00037	HDL00038	—
3/4 NPT Fitting		6½	165.1	2500	170	26	—	HDL00039	HDL00040
		7¼	184.2	750	45	7	HDL00041	HDL00042	—
		7¼	184.2	3000	182	28	—	HDL00043	HDL00044
		9	228.6	1000	49	8	HDL00045	HDL00046	—
		9	228.6	4000	194	30	—	HDL00047	HDL00048
		10½	266.7	750	31	5	HDL00049	HDL00050	—
		10½	266.7	3000	124	19	—	HDL00051	HDL00052
		10¾	273.1	1250	51	8	HDL00053	HDL00054	—
3/4 NPT Fitting	10¾	273.1	5000	202	31	—	HDL00055	HDL00056	
	12½	317.5	1500	52	8	—	HDL00057	—	
	12½	317.5	6000	208	32	—	—	HDL00058	
	13¾	346.1	1000	32	5	HDL00059	HDL00060	—	
	13¾	346.1	4000	127	20	—	HDL00061	HDL00062	
	16	406.4	2000	54	8	—	HDL00063	—	
	16	406.4	8000	216	33	—	—	HDL00064	
	19¼	489.0	2500	56	9	—	HDL00065	—	
19¼	489.0	10000	223	35	—	—	HDL00066		

Ordering Information

Stock Heaters

Part Numbers listed above are for 1/2" and 3/4" NPT Brass Screw Plug Cartridge Immersion Heaters with Type CM termination and 10" long leads. **Standard lead time is 72 hours.**

Custom Engineered/Manufactured Heaters

Because an electric heater can be very application specific, for sizes and ratings not listed, **TEMPCO** will design and manufacture a Cartridge Immersion Heater to meet your requirements. **Standard lead time is 3 weeks.**

Please Specify the following:

- Screw Plug NPT Size
- Screw Plug material (Brass or SS)
- Sheath material (Incoloy®, 321 SS)
- Element Watt Density
- Immersion Length
- Heated Length
- Wattage
- Voltage
- Termination types
- Lead Length

Cartridge Heater — Moisture Resistant Terminations

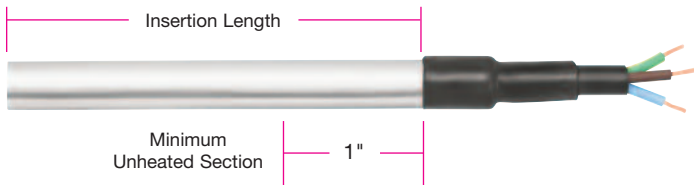

Type M1 Polyolefin Liquid Barrier

Available on HDC, HDM, and LDC cartridge heaters

A liquid barrier used for low temperature applications primarily in refrigeration or food service applications. The seal bonds to both the heater and the leads.

- Minimum 1" unheated section at the lead end is required.
- Three conductor SJO type cord.
- Available only in certain diameters. Heaters smaller than 1/2" diameter require an adapter.
- **Standard 10" (254 mm) leads. Specify longer leads.**

Type M2 Potted End Seal

Available on HDC, HDM and LDC cartridge heaters

Potted end seals help to protect the heater from moisture or contamination from plastic material, cleaning solvents, or oils. The bottom end disc seal is welded in.

M2A Cement potting with silicone varnish. Fiberglass lead wires externally connected.

- Cement potting temperature rating: 1000°F (538°C)
- Standard lead wire temperature rating: 482°F (250°C)

M2B Silicone rubber potting. Silicone rubber lead wires internally connected.

- Silicone rubber potting temperature rating: 450°F (232°C)
- Standard lead wire temperature rating: 392°F (200°C)

M2C High temperature epoxy potting. Teflon® lead wires internally connected.

- High temp. epoxy potting temp. rating: 450°F (232°C)
- Standard lead wire temperature rating: 392°F (200°C)

M2D Low temperature epoxy potting. Teflon® lead wires internally connected.

- Low temp. epoxy potting temp. rating: 266°F (130°C), UL rated to 194°F (90°C)
- Standard lead wire temperature rating: 392°F (200°C)

M2E Cement potting with silicone varnish. Fiberglass lead wires internally connected.

- Cement potting temperature rating: 1000°F (548°C)
- Standard lead wire temperature rating: 482°F (250°C)
- Minimum of 3/8" up to 1" unheated section at the lead end is required.
- **Standard 10" (254 mm) leads. Specify longer leads.**

Type M3 Teflon® End Plug Seal

Available on HDC and HDM cartridge heaters

A moisture resistant Teflon® seal that is swaged in during the manufacturing process with Teflon® insulated lead wire.

- Minimum 3/8" up to 1" unheated section at the lead end is required.
- Teflon® seal temperature rating: 392°F (200°C)
- Standard lead wire temperature rating: 392°F (200°C)
- **Standard 10" (254 mm) leads. Specify longer leads. Leads longer than 60" require a splice.**

TYPE M2A



TYPE M2B, M2C, M2D and M2E



 M2A and M2E are available through the Hi-Density Cartridge Heater Terminator Program for 2nd or 3rd Day Shipping





Cartridge Heater — Moisture Resistant Terminations

Type SA Sealed Corrugated Armor Cable

Available on 1/2" Diameter and Larger HDC, HDM and LDC cartridge heaters

A liquid-proof stainless steel corrugated metal hose is silver brazed to the end of the cartridge heater. The end disc of the heater is also welded or brazed. This termination provides a positive seal against moisture and contamination entering the heater.

- ▶ Minimum 3/8" up to 1" unheated section at the lead end is required.
- ▶ Standard fiberglass lead wire temperature rating
HDC and HDM: 842°F (450°C), LDC: 482°F (250°C)
- ▶ **Standard 10" (254 mm) cable over 12" (305 mm) leads.**
Specify longer leads or cable.



Cartridge Heater — Flexible Spring Abrasion Resistant Terminations

Type S1 Flexible Spring

Available on HDC, HDM, and LDC cartridge heaters.

The leads are reinforced with a steel spring for applications with extreme flexing. The spring is mechanically fastened or silver brazed.

S1A Mechanically fastened spring.

S1B Silver brazed spring.

- ▶ Minimum 3/8" up to 1" unheated section at the lead end is required.
- ▶ Standard fiberglass lead wire temperature rating
HDC and HDM: 842°F (450°C), LDC: 482°F (250°C)
- ▶ **Standard 10" (254 mm) leads.** Specify longer leads.

Dimensions for Type S1

	Diameter		Fig.	"A" Dim.		"B" Dim.	
	in	mm		in	mm	in	mm
Hi-Density Cartridge Heaters	1/4	6.35	1	11/16	17.46	5/16	7.94
	5/16	7.94	1	11/16	17.46	7/16	11.11
	3/8	9.53	1	11/16	17.46	7/16	11.11
	1/2	12.70	1	13/16	20.64	9/16	14.29
	5/8	15.88	1	1	25.40	3/4	19.05
	3/4	19.05	1	1-1/4	31.75	7/8	22.23
	1	25.40	2	5/8	15.88	5/8	15.88
Low-Density Cartridge Heaters	3/16	4.76	—	—	—	—	—
	1/4	6.35	1	11/16	17.46	5/16	7.94
	3/8	9.53	1	11/16	17.46	7/16	11.11
	1/2	12.70	1	13/16	20.64	9/16	14.29
	5/8	15.88	2	7/16	11.11	9/16	14.29
	3/4	19.05	2	1/2	12.70	9/16	14.29
	7/8	22.23	2	5/8	15.88	9/16	14.29
	15/16	23.81	2	5/8	15.88	5/8	15.88
	1	25.40	2	5/8	15.88	5/8	15.88
	1-1/4	31.75	2	5/8	15.88	5/8	15.88

TYPE S1 Fig. 1

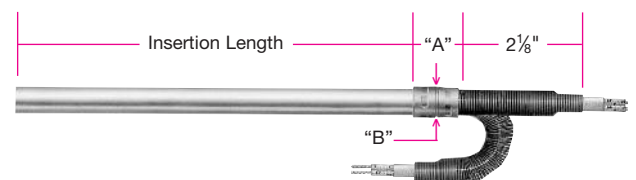

TYPE S1 Fig. 2

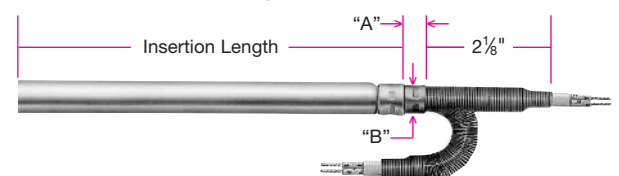



Abrasion Resistant Terminations

Cartridge Heater — Flexible Braid Abrasion Resistant Terminations

TYPE W Fig. 1

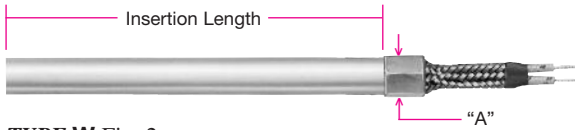

TYPE W Fig. 2

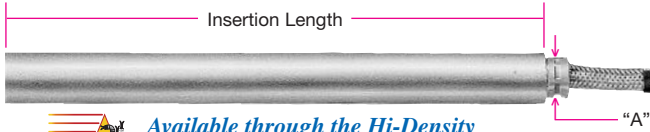

Available through the Hi-Density Cartridge Heater Terminator Program for 2nd or 3rd Day Shipping

Diameter		Fig.	"A" Dim./HD		"A" Dim./LD	
in	mm		in	mm	in	mm
3/16	4.76	1	—	—	1/4	6.35
1/4	6.35	1	5/16	7.94	5/16	7.94
5/16	7.94	1	3/8	9.53	—	—
3/8	9.53	2	3/8	9.53	3/8	9.53
1/2	12.70	2	7/16	11.11	7/16	11.11
5/8	15.88	2	9/16	14.29	9/16	14.29

Type W Wire Braided Leads

Available on HDC, HDM, and LDC cartridge heaters

Stainless steel braid over fiberglass leads offers sharp bending not possible with armor cable, as well as abrasion protection.

- Minimum 3/8" up to 1" unheated section at the lead end is required.
- Standard lead wire temperature rating
HDC and HDM: 842°F (450°C), LDC: 482°F (250°C)
- **Standard 10" (254 mm) braid over 12" (305 mm) leads.**
Specify longer braid/leads.

Diameter		Fig.	"A" Dim./HD		"A" Dim./LD	
in	mm		in	mm	in	mm
3/4	19.05	2	9/16	14.29	9/16	14.29
7/8	22.23	2	—	—	9/16	14.29
15/16	23.81	2	—	—	9/16	14.29
1	25.40	2	9/16	14.29	9/16	14.29
1-1/4	31.75	2	—	—	9/16	14.29

Type W2 Embedded Wire Braided Leads

Available on HDC, HDM and LDC cartridge heaters

Stainless Steel braid embedded into seal offers moisture resistance and abrasion protection.

W2A Fiberglass Leads with Cement Potting

- Cement potting temperature rating: 1000°F (538°C)
- Standard lead wire temperature rating: 482°F (250°C)

W2B Teflon® Leads with High Temperature Epoxy

- High temperature epoxy temp. rating: 450°F (232°C)
- Standard lead wire temperature rating: 392°F (200°C)

W2C Teflon® Leads with Low Temperature Epoxy

- Low temperature epoxy temp. rating: 266°F (130°C)
UL rated to 194°F (90°C)
- Standard lead wire temperature rating: 392°F (200°C)

- Minimum 3/8" up to 1" unheated section at the lead end is required.

- **Standard 10" (254 mm) braid over 12" (305 mm) leads.**
Specify longer braid/leads.



Type W3 Swaged-In Wire Braided Leads

Available on HDC and HDM cartridge heaters

Stainless steel braid over fiberglass leads offers sharp bending not possible with armor cable, as well as abrasion protection. In addition, Type W3 offers contamination resistance due to the Teflon® seal required for holding the wire braid.

- Minimum 3/8" up to 1" unheated section at the lead end is required.

- Teflon® Seal temperature rating: 392°F (200°C)
- Standard lead wire temperature rating: 842°F (450°C)
- **Standard 10" (254 mm) braid over 12" (305 mm) leads.**
Specify longer braid/leads.





Cartridge Heater — Armor Cable Abrasion Resistant Terminations

Type CS Straight Armor Cable Directly Attached to Sheath

Available on HDC, HDM, and LDC cartridge heaters

The armor cable is directly attached to the cartridge heater, eliminating the coupling, to maintain an overall diameter equal to or smaller than the cartridge diameter.

CSA Galvanized armor cable – minimum diameter: 5/16"

CSB Stainless steel armor cable – minimum diameter: 5/16"

- Minimum 3/8" up to 1" unheated section at the lead end is required.
- Heaters with an OD of 3/4" or larger require reducing diameter washer
- Standard fiberglass lead wire temperature rating
HDC and HDM: 842°F (450°C), LDC: 482°F (250°C)
- **Standard 10" (254 mm) cable over 12" (305 mm) leads.**
Specify longer leads or cable.



Type C1 Straight Armor Cable with Coupling

Available on HDC, HDM, or LDC cartridge heaters

Armor cable provides the maximum in protection for abrasive, jagged environments. The coupling between the cartridge and the armor cable is mechanically fastened or silver brazed.

C1A Galvanized armor cable, mechanically fastened

C1B Stainless steel armor cable, mechanically fastened

- Standard lead wire temperature rating: 482°F (250°C)

C1C Galvanized armor cable, silver brazed

C1D Stainless steel armor cable, silver brazed

- Standard fiberglass lead wire temperature rating
HDC and HDM: 842°F (450°C), LDC: 482°F (250°C)

- Minimum 3/8" up to 1" unheated section at the lead end is required.
- **Standard 10" (254 mm) cable over 12" (305 mm) leads.**
Specify longer leads or cable.

TYPE C1 Fig. 1

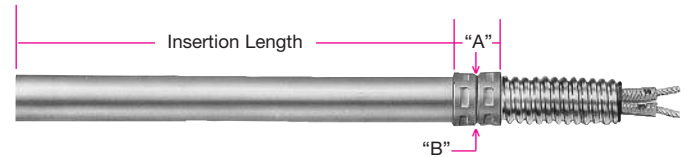

C1A and C1B are available through the Hi-Density Cartridge Heater Terminator Program for Same or Next Day Shipping

Dimensions for Type C1

	Diameter		Fig.	"A" Dim.		"B" Dim.		Cable Dia.
	in	mm		in	mm	in	mm	
Hi-Density Cartridge Heaters	1/4	6.35	1	11/16	17.46	5/16	7.94	1/4
	5/16	7.94	1	11/16	17.46	7/16	11.11	1/4
	3/8	9.53	1	11/16	17.46	7/16	11.11	3/8
	1/2	12.70	1	13/16	20.64	9/16	14.29	1/2
	5/8	15.88	1	1	25.40	3/4	19.05	1/2
	3/4	19.05	1	1-1/4	31.75	7/8	22.23	1/2
	1	25.40	2	5/8	15.88	5/8	15.88	1/2
Low-Density Cartridge Heaters	3/16	4.76	—	—	—	—	—	—
	1/4	6.35	1	11/16	17.46	5/16	7.94	1/4
	3/8	9.53	1	11/16	17.46	7/16	11.11	3/8
	1/2	12.70	1	13/16	20.64	9/16	14.29	1/2
	5/8	15.88	2	7/16	11.11	9/16	14.29	1/2
	3/4	19.05	2	1/2	12.70	9/16	14.29	1/2
	7/8	22.23	2	5/8	15.88	9/16	14.29	1/2
	15/16	23.81	2	5/8	15.88	5/8	15.88	1/2
	1	25.40	2	5/8	15.88	5/8	15.88	1/2

TYPE C1 Fig. 2

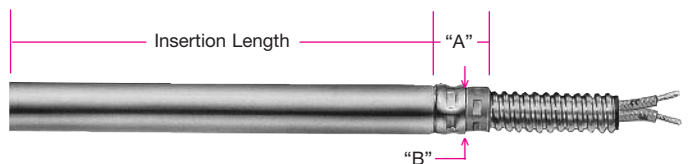

Cartridge Heaters



Right-Angle Terminations

Cartridge Heater — Plain Leads Right-Angle Terminations

TYPE R1 Fig. 1



TYPE R1 Fig. 2

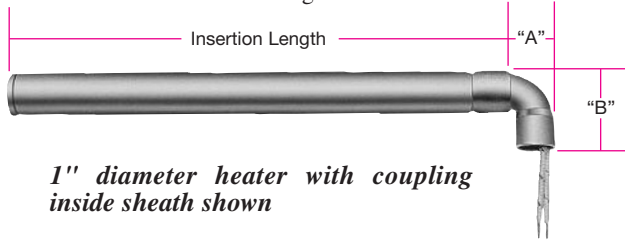

Type R1 Right-Angle Leads with Copper Elbow

Available on HDC, HDM, and LDC cartridge heaters

This termination is used when space is limited. The copper elbow is mechanically fastened or silver brazed.

R1A Mechanically fastened

R1B Silver brazed

- ▶ Minimum 3/8" up to 1" unheated section at the lead end is required.
- ▶ Standard fiberglass lead wire temperature rating
HDC and HDM: 842°F (450°C), LDC: 482°F (250°C)
- ▶ **Standard 10" (254 mm) leads.** Specify longer leads.

Dimensions for Type R1

	Diameter		Fig.	"A" Dim.		"B" Dim.	
	in	mm		in	mm	in	mm
Hi-Density Cartridge Heater	1/4	6.35	1	3/4	19.05	3/4	19.05
	5/16	7.94	1	15/16	23.81	15/16	23.81
	3/8	9.53	1	15/16	23.81	15/16	23.81
	1/2	12.70	1	1-1/4	31.75	1-1/4	31.75
	5/8	15.88	1	1-1/4	31.75	1-1/4	31.75
	3/4	19.05	1	1-3/4	44.45	1-1/4	31.75
	1	25.40	2	1-1/8	28.58	1-3/8	34.93
Low Density Cartridge Heater	3/16	4.76	—	—	—	—	—
	1/4	6.35	1	3/4	19.05	3/4	19.05
	3/8	9.53	1	15/16	23.81	15/16	23.81
	1/2	12.70	1	1-1/4	31.75	1-1/4	31.75
	5/8	15.88	2	11/16	17.46	1-1/4	31.75
	3/4	19.05	2	3/4	19.05	1-1/4	31.75
	7/8	22.23	2	3/4	19.05	1-3/8	34.93
	15/16	23.81	2	1-1/8	28.58	1-3/8	34.93
	1	25.40	2	1-1/8	28.58	1-3/8	34.93
	1-1/4	31.75	2	1-1/8	28.58	1-3/8	34.93



Note: For Right-Angle Sheath Options, see page 2-53.





Cartridge Heater — Flexible Spring Abrasion Resistant Right-Angle Terminations

Type R2 Right-Angle Leads

Available on HDC, HDM, and LDC cartridge heaters

This termination is used when space is limited. Not suitable for abrasive environments. Same as C3 and W1 except plain leads. Various lead end finishes are available as listed below:

- R2A** Cement potting, no lead end disc
 - Cement potting temperature rating: 1000°F (538°C)
 - Standard fiberglass lead wire temperature rating: 482°F (250°C)
 - R2B** Cement potting, welded lead end disc
 - Cement potting temperature rating: 1000°F (538°C)
 - Standard fiberglass lead wire temperature rating: 482°F (250°C)
 - R2C** Silicone rubber potting, welded lead end disc
 - Silicone Rubber potting temperature rating: 450°F (232°C)
 - Standard silicone rubber lead wire temperature rating: 392°F (200°C)
 - R2D** High temperature epoxy potting, welded lead end disc
 - High Temperature epoxy potting temperature rating: 450°F (232°C)
 - Standard Teflon® lead wire temperature rating: 392°F (200°C)
 - R2E** Low temperature epoxy potting, welded lead end disc
 - Low Temperature epoxy potting temperature rating: 266°F (130°C)
 - Standard Teflon® lead wire temperature rating: 392°F (200°C)
- Minimum 3/8" up to 1" unheated section at the lead end is required.
 ➤ **Standard 10" (254 mm) leads.** Specify other lead lengths.

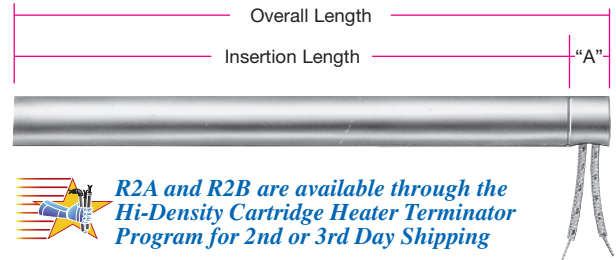

R2A and R2B are available through the Hi-Density Cartridge Heater Terminator Program for 2nd or 3rd Day Shipping

Dimensions for types R2

Diameter		Availability		"A" Dim.	
in	mm	HD	LD	in	mm
3/16	4.76	No	No	—	—
1/4	6.35	Yes	Yes	5/16	7.94
5/16	7.94	Yes	No	5/16	7.94
3/8	9.53	Yes	Yes	7/16	11.11
1/2	12.70	Yes	Yes	9/16	14.29
5/8	15.88	Yes	Yes	9/16	14.29
3/4	19.05	Yes	Yes	9/16	14.29
7/8	22.23	No	Yes	5/8	15.88
15/16	23.81	No	Yes	5/8	15.88
1	25.40	Yes	Yes	5/8	15.88
1-1/4	31.75	No	Yes	5/8	15.88

Type S2 Right-Angle Spring

Available on HDC, HDM, and LDC cartridge heaters

The leads are reinforced with a steel spring for applications with extreme flexing. The spring is mechanically fastened or silver brazed.

- S2A** Mechanically fastened spring
- S2B** Silver brazed spring
- Minimum 3/8" up to 1" unheated section at the lead end is required.
- Standard fiberglass lead wire temperature rating
HDC and HDM: 842°F (450°C), LDC: 482°F (250°C)
- **Standard 10" (254 mm) leads.** Specify longer leads.

Dimensions for Type S2

	Diameter		Fig.	"A" Dim.		"B" Dim.	
	in	mm		in	mm	in	mm
Hi-Density Cartridge Heaters	1/4	6.35	1	3/4	19.05	3/4	19.05
	5/16	7.94	1	15/16	23.81	15/16	23.81
	3/8	9.53	1	15/16	23.81	15/16	23.81
	1/2	12.70	1	1-1/4	31.75	1-1/4	31.75
	5/8	15.88	1	1-1/4	31.75	1-1/4	31.75
	3/4	19.05	1	1-3/4	44.45	1-1/4	31.75
	1	25.40	2	1-1/8	28.58	1-3/8	34.93
Low-Density Cartridge Heaters	3/16	4.76	—	—	—	—	—
	1/4	6.35	1	3/4	19.05	3/4	19.05
	3/8	9.53	1	15/16	23.81	15/16	23.81
	1/2	12.70	1	1-1/4	31.75	1-1/4	31.75
	5/8	15.88	2	11/16	17.46	1-1/4	31.75
	3/4	19.05	2	3/4	19.05	1-1/4	31.75
	7/8	22.23	2	3/4	19.05	1-3/8	34.93
	15/16	23.81	2	1-1/8	28.58	1-3/8	34.93
	1	25.40	2	1-1/8	28.58	1-3/8	34.93
1-1/4	31.75	2	1-1/8	28.58	1-3/8	34.93	

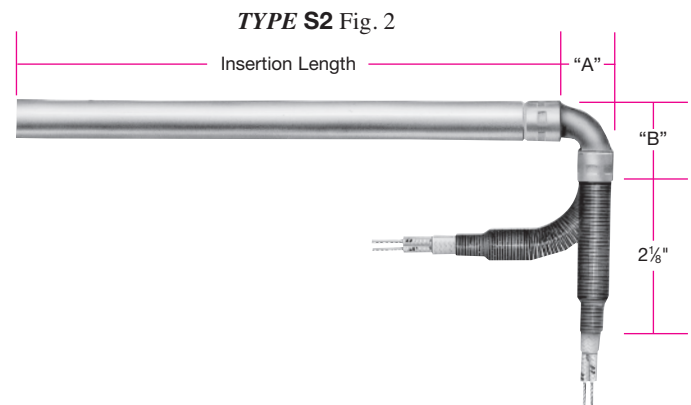
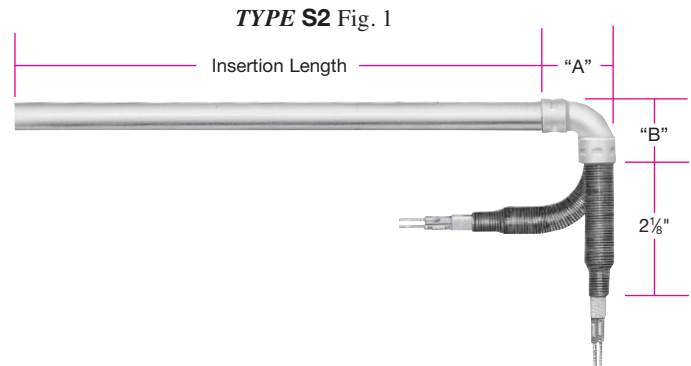

Cartridge Heaters



Right-Angle Terminations

Cartridge Heater — Flexible Braid Abrasion Resistant Right-Angle Terminations

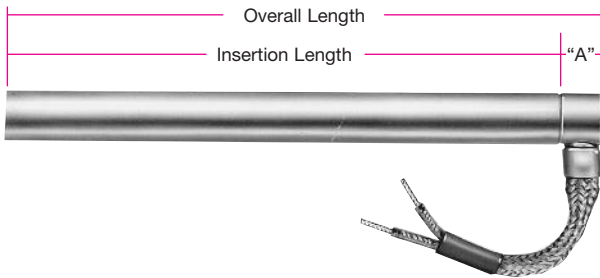

 Available through the Hi-Density Cartridge Heater Terminator Program for 2nd or 3rd Day Shipping

Type W1 Right-Angle Wire Braided Leads

Available on HDC, HDM, and LDC cartridge heaters

Stainless steel braid over fiberglass leads for abrasion protection, mechanically crimped to the cartridge sheath at 90°. Wire braid offers extreme flexibility not possible with armor cable. Various lead end finishes are available as listed below.

W1A Cement potting and silicone varnish, no lead end disc.

- Cement potting temperature rating: 1000°F (538°C)
- Standard lead wire temperature rating: 482°F (250°C)

W1B Welded lead end disc.

- Cement potting temperature rating: 1000°F (538°C)
- Standard lead wire temperature rating: 482°F (250°C)
- Minimum 3/8" up to 1" unheated section at the lead end is required.
- **Standard** 10" (254 mm) braid over 12" (305 mm) leads. Specify longer braid or leads.

Dimensions for Type W1

Diameter		Availability		"A" Dim.	
in	mm	HD	LD	in	mm
3/16	4.76	No	No	—	—
1/4	6.35	Yes	Yes	5/16	7.94
5/16	7.94	Yes	No	5/16	7.94
3/8	9.53	Yes	Yes	7/16	11.11
1/2	12.70	Yes	Yes	9/16	14.29
5/8	15.88	Yes	Yes	9/16	14.29
3/4	19.05	Yes	Yes	9/16	14.29
7/8	22.23	No	Yes	5/8	15.88
15/16	23.81	No	Yes	5/8	15.88
1	25.40	Yes	Yes	5/8	15.88
1-1/4	31.75	No	Yes	5/8	15.88



Note: For Right-Angle Sheath Options, see page 2-53.





Cartridge Heater — Armor Cable Abrasion Resistant Right-Angle Terminations

Type C2 Right-Angle Armor Cable with Copper Elbow

Available on HDC, HDM, and LDC cartridge heaters

Armor cable provides the maximum in protection for abrasive, jagged environments. The copper elbow between the cartridge and the armor cable is mechanically fastened or silver brazed.

C2A Galvanized armor cable, mechanically fastened

C2B Stainless steel armor cable, mechanically fastened

C2C Galvanized armor cable, silver brazed

C2D Stainless steel armor cable, silver brazed

- Minimum 3/8" up to 1" unheated section at the lead end is required.
- Standard fiberglass lead wire temperature rating
HDC and HDM: 842°F (450°C), LDC: 482°F (250°C)
- **Standard 10" (254 mm) cable over 12" (305 mm) leads.**
Specify longer cable or leads.

Dimensions for Type C2 Hi-Density Cartridge Heaters

Diameter in mm	Fig.	"A" Dim.		"B" Dim.		Cable Dia.
		in	mm	in	mm	
1/4 6.35	1	3/4	19.05	3/4	19.05	1/4
5/16 7.94	1	15/16	23.81	15/16	23.81	1/4
3/8 9.53	1	15/16	23.81	15/16	23.81	3/8
1/2 12.70	1	1-1/4	31.75	1-1/4	31.75	1/2
5/8 15.88	1	1-1/4	31.75	1-1/4	31.75	1/2
3/4 19.05	1	1-3/4	44.45	1-1/4	31.75	1/2
1 25.40	2	1-1/8	28.58	1-3/8	34.93	1/2

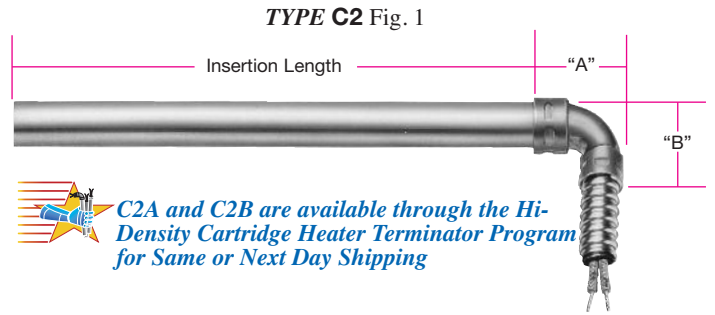

C2A and C2B are available through the Hi-Density Cartridge Heater Terminator Program for Same or Next Day Shipping

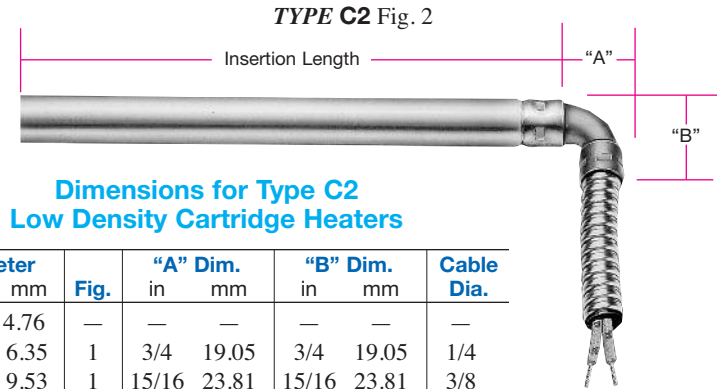

Dimensions for Type C2 Low Density Cartridge Heaters

Diameter in mm	Fig.	"A" Dim.		"B" Dim.		Cable Dia.
		in	mm	in	mm	
3/16 4.76	—	—	—	—	—	—
1/4 6.35	1	3/4	19.05	3/4	19.05	1/4
3/8 9.53	1	15/16	23.81	15/16	23.81	3/8
1/2 12.70	1	1-1/4	31.75	1-1/4	31.75	1/2
5/8 15.88	2	11/16	17.46	1-1/4	31.75	1/2
3/4 19.05	2	3/4	19.05	1-1/4	31.75	1/2
7/8 22.23	2	3/4	19.05	1-3/8	34.93	1/2
15/16 23.81	2	1-1/8	28.58	1-3/8	34.93	1/2
1 25.40	2	1-1/8	28.58	1-3/8	34.93	1/2
1-1/4 31.75	2	1-1/8	28.58	1-3/8	34.93	1/2

Type C3 Right-Angle Armor Cable

Available on HDC, HDM, and LDC cartridge heaters

Use this termination when space is limited and maximum protection is required. The armor cable is tack welded or silver brazed to the cartridge sheath at 90°. The sheath extension is potted with cement. Various lead end finishes are available as listed below.

C3A Cement potting and silicone varnish with no lead end disc, galvanized cable

C3B Cement potting and silicone varnish with no lead end disc, stainless steel cable

C3C Welded lead end disc, with galvanized cable

C3D Welded lead end disc, with stainless steel cable

- Minimum 3/8" up to 1" unheated section at the lead end is required.
- Cement potting temperature rating: 1000°F (538°C)
Standard fiberglass lead wire temperature rating: 482°F (250°C)
- **Standard 10" (254 mm) armor cable over 12" (305 mm) leads.**
Specify longer cable or leads.

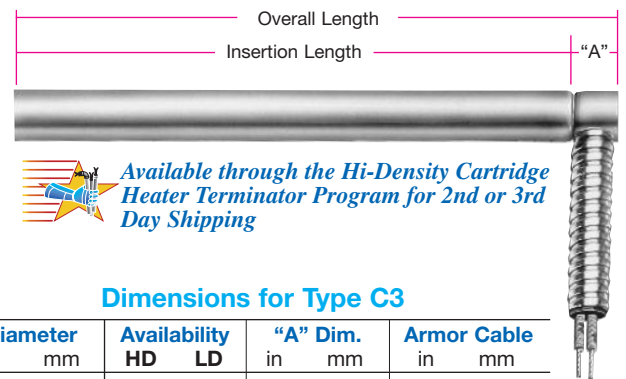

Available through the Hi-Density Cartridge Heater Terminator Program for 2nd or 3rd Day Shipping

Dimensions for Type C3

Diameter in mm	Availability HD LD	"A" Dim.		Armor Cable	
		in	mm	in	mm
3/16 4.76	No No	—	—	—	—
1/4 6.35	Yes Yes	5/16	7.94	1/4	6.35
5/16 7.94	Yes No	5/16	7.94	1/4	6.35
3/8 9.53	Yes Yes	7/16	11.11	3/8	9.53
1/2 12.70	Yes Yes	9/16	14.29	1/2	12.70
5/8 15.88	Yes Yes	9/16	14.29	1/2	12.70
3/4 19.05	Yes Yes	9/16	14.29	1/2	12.70
7/8 22.23	No Yes	5/8	15.88	1/2	12.70
15/16 23.81	No Yes	5/8	15.88	1/2	12.70
1 25.40	Yes Yes	5/8	15.88	1/2	12.70
1-1/4 31.75	No Yes	5/8	15.88	1/2	12.70

Cartridge Heaters



High Temperature Terminations

Cartridge Heater — Screw Terminations

Type T1 Screw Terminals

Available on LD type cartridge heaters only

For use with leads, crimp terminals, or bus bars. Includes washers and nuts.

- ▶ Minimum 1/2" unheated section at the lead end is required.
- ▶ Diameters available: 3/4", 7/8", 15/16", 1", and 1-1/4".
- ▶ **Standard:** screw #6-32 x 3/4" long



Diameter	in	3/4	7/8	15/16	1	1-1/4
	mm	19.05	22.23	23.81	25.40	31.75
"A" Dimension	in	3/8	7/16	7/16	1/2	1/2
	mm	9.53	11.11	11.11	12.70	12.70

Type T2 Screw Terminals

Available on HDC and HDM type cartridge heaters only

For use with leads, crimp terminals, or bus bars. Includes washers and nuts.

- ▶ Minimum 1/2" unheated section at the lead end is required.
- ▶ Diameters available: HD — 5/8", 3/4", 1"
HDM — 16 mm and 20 mm
- ▶ **Standard:** screw #8-32



Cartridge Heater — High Temperature Termination

Type B Heat Resistant Ceramic Bead Insulation

Available on HDC, HDM, and LDC cartridge heaters.

The ultimate in high temperature lead protection. Allows for the attachment of flexible leads to the heater away from the high heat area. Used when the ambient temperature exceeds 842°F (450°C).

- ▶ **Standard** 10" (254 mm) solid nickel pins insulated with ball and socket construction type ceramic beads



 Available through the Hi-Density Cartridge Heater Terminator Program for Same or Next Day Shipping

Type BL Heat Resistant Ceramic Bead Insulation with Leads

Available on HDC, HDM, and LDC cartridge heaters.

High temperature flexible leads are connected away from the high heat area.

- ▶ **Standard** 6" (254 mm) solid nickel pins insulated with ball and socket construction type ceramic beads and 10" (254 mm) fiberglass leads rated at 842°F (450°C). Specify longer leads.



 Available through the Hi-Density Cartridge Heater Terminator Program for Same or Next Day Shipping



Cartridge Heater — Double End Terminations

Type T4 Double End Terminal Pin

Available on HDC, HDM, and LDC cartridge heaters

For those applications in which wiring from both ends is an advantage. Various seals are available:

- T4A** Cement potting seal with silicone varnish
 - Cement potting temperature rating: 1000°F (538°C)
- T4B** High temp. moisture resistant epoxy seal
 - High temp. epoxy temp. rating: 450°F (232°C)
- T4C** Low temp. moisture resistant epoxy seal
 - Low temp. epoxy temp. rating: 266°F (130°C)
- Minimum 1" unheated section at each end is required.
- **Standard** terminal pin length is 2".



Type F1 Double End Flexible Leads

Available on HDC, HDM, and LDC cartridge heaters

For applications in which it is an advantage to wire from both ends. The leads are internally connected and can be bent sharply as they exit the potted ends. Various seals are available:

- F1A** Fiberglass leads with cement potting seal and silicone varnish
 - Cement potting temperature rating: 1000°F (532°C)
 - Standard lead wire temperature rating: 482°F (250°C)
- F1B** Teflon® leads with high temp. moisture resistant epoxy seal
 - High temp. epoxy temperature rating: 450°F (232°C)
 - Standard lead wire temperature rating: 392°F (200°C)
- F1C** Teflon® leads with low temp. moisture resistant epoxy seal
 - Low temp. epoxy temperature rating: 266°F (130°C)
 - Standard lead wire temperature rating: 392°F (200°C)
- Minimum 1" unheated section at each end is required.
- **Standard** 10" leads. Specify longer leads. Leads longer than 60" require a splice.

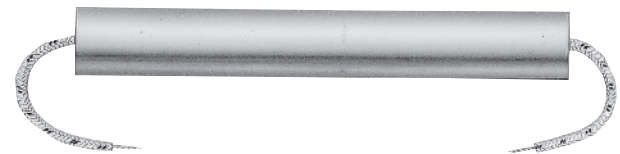

Type T3 Double End Screw Terminals

Available on HDC, HDM, and LDC cartridge heaters from 1/2" to 1-1/4" diameter

A double ended heater with quick change wiring screw terminals. Includes zinc plated washers and nuts.

- Minimum 1/2" unheated section at each end is required.

Standard screw sizes:

- 1/2" diameter — #8-32 × 3/4" screws
- 5/8" to 1-1/4" diameter — #10-32 × 3/4" screws





Mounting Fitting Termination & Option

Cartridge Heater Termination — Single Ended National Pipe Thread (NPT) Fitting

TYPE CM Fig. 1 – Fitting Flush with Lead End of Sheath



CMB & CMP are available through the Hi-Density Cartridge Heater Terminator Program for 2nd or 3rd Day Shipping

NOTE: Stainless steel fittings are available through the Terminator program for heaters 1/2" diameter and larger.



Note: Fitting can be offset from end of sheath. See Figure 2, Single Threaded Mounting Options CMV and CMW below.

Standard NPT Bushing Dimensions (Fig. 1 & Fig. 2)

Heater Diameter (in)	NPT Size	"A"	"B"	"C"
1/4	1/8-27	3/8	3/16	7/16
3/8	1/4-18	1/2	3/16	9/16
1/2	3/8-18	9/16	1/4	11/16
5/8	1/2-14	5/8	1/4	7/8
3/4	3/4-14	3/4	1/4	1-1/8
7/8	1-11 1/2	3/4	1/4	1-3/8
1	1-11 1/2	3/4	1/4	1-3/8
1-1/4	1 1/4-11 1/2	7/8	5/16	1-3/4

Type CM Single Threaded Fitting Mounting Termination Fitting Flush with Lead End of Sheath

Available on HDC, HDM, and LDC cartridge heaters

A single threaded pipe fitting is attached to the end of a cartridge heater to allow for installation into a threaded hole. Brass fittings are silver brazed and stainless steel fittings are heli-arc welded. Available with the potting seals listed in the table.

Potted end seals help to protect the heater from moisture or contamination from plastic material, cleaning solvents, or oils. The bushing cavity can be sealed with various materials such as:

CMA/CMN Low temperature epoxy potting — 266°F (130°C), UL rated to 194°F (90°C)
Teflon® leads internally connected, rated 392°F (200°C).

CMB/CMP Hi-temp cement potting with silicone varnish — 1000°F (538°C)
Fiberglass leads internally connected, rated 482°F (250°C).

CMC/CMQ Silicone rubber potting — 450°F (232°C)
Silicone rubber leads internally connected, rated 392°F (200°C).

CMD/CMR High temperature epoxy potting — 450°F (232°C)
Teflon® leads internally connected, rated 392°F (200°C).

➤ A minimum of 1/4" cold section below the bushing is required.

➤ **Standard 10" (254 mm) leads. Specify longer leads.**

Type Codes for Single Threaded Fittings

Potting Seal Type	Fitting Material	
	Brass	Stainless Steel
Low Temp Epoxy	CMA	CMN
Hi-Temp Cement	CMB	CMP
Silicone Rubber	CMC	CMQ
Hi-Temp Epoxy	CMD	CMR

Single Ended National Pipe Thread (NPT) Fitting Option

TYPE CM Fig. 2 – Fitting Offset from Lead End of Sheath

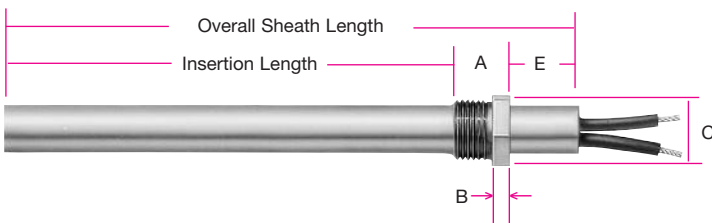

Type CM Single Threaded Fitting Mounting Option Fitting Offset from Lead End of Sheath

Available on HDC, HDM, and LDC cartridge heaters

This mounting option available with many terminations attaches a fitting offset from the lead end of the sheath. This option is useful when the lead wires need to be kept away from the heated area. Brass fittings are silver brazed and stainless steel fittings are offset heli-arc welded.

CMV Brass Fitting

CMW Stainless Steel Fitting

➤ Specify offset dimension "E" when ordering.

➤ A termination must be specified separately.

Hi-Density Cartridge Immersion Heater Specifically Designed for Heating Water & Other Liquids



See Page 2-23.



Cartridge Heater — Double Ended National Pipe Thread (NPT)

Type CN Double Threaded Fitting Mounting Termination Fitting Flush with Lead End of Sheath

Available on HDC, HDM, and LDC cartridge heaters

A double threaded pipe fitting is attached to the end of a cartridge heater to allow for installation into a threaded hole. Brass fittings are silver brazed and stainless steel fittings are heli-arc welded.

Standard NPT Bushing Dimensions

Heater Diameter (in)	NPT Size	"A"	"B"	"C"
1/4	1/8-27	3/8	1/4	7/16
3/8	1/4-18	1/2	1/4	9/16
1/2	3/8-18	9/16	1/4	11/16
5/8	1/2-14	5/8	5/16	7/8
3/4	3/4-14	3/4	3/8	1-1/8
7/8	1-11 1/2	3/4	3/8	1-3/8
1	1-11 1/2	3/4	3/8	1-3/8
1-1/4	1 1/4-11 1/2	7/8	1/2	1-3/4

Type Codes for Double Threaded Fittings

Potting Seal Type	Fitting Material	
	Brass	Stainless Steel
Low Temp Epoxy	CNA	CNN
Hi-Temp Cement	CNB	CNP
Silicone Rubber	CNC	CNQ
Hi-Temp Epoxy	CND	CNR

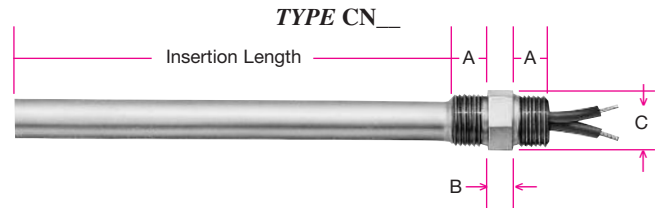

Potted end seals help to protect the heater from moisture or contamination from plastic material, cleaning solvents, or oils. The bushing cavity can be sealed with various materials such as:

- CNA/CNN Low temperature epoxy potting** — 266°F (130°C), UL rated to 194°F (90°C)
Teflon® leads internally connected, rated 392°F (200°C).
 - CNB/CNP Hi-temp cement potting w/ silicone varnish** — 1000°F (538°C)
Fiberglass leads internally connected, rated 482°F (250°C).
 - CNC/CNQ Silicone rubber potting** — 450°F (232°C)
Silicone rubber leads internally connected, rated 392°F (200°C).
 - CND/CNR High temperature epoxy potting** — 450°F (232°C)
Teflon® leads internally connected, rated 392°F (200°C).
- A minimum of 1/4" cold section below the bushing is required.
➤ **Standard 10" (254 mm) leads. Specify longer leads.**

Cartridge Heater Immersion Heater Top Hat Screw Plug Termination

Type TH Top Hat Screw Plug

Available on HDC (except 1/8") and HDM cartridge heaters

This heater has a header cap as an integral part of the fitting. Leads exit through small holes which are sealed with epoxy for moisture protection.

Low temperature epoxy potting — 266°F (130°C),
UL rated to 194°F (90°C)

Teflon® leads internally connected, rated 392°F (200°C).

➤ **Standard 10" (254 mm) leads. Specify longer leads.**

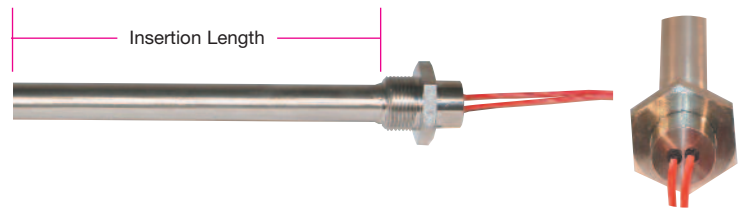

Cartridge Heater — Bulkhead Fitting Termination

Type BF Bulkhead Fitting

Available on HDC and LDC 1/2" and 5/8" cartridge heaters

A 5/8-18 UNF fitting is attached to the end of the cartridge heater to allow for mounting the heater to the wall of a tank or enclosure. Brass fittings are silver brazed and stainless steel fittings are heli-arc welded. Includes a copper washer and jam nut. The lead wires are internally connected. Available with the potting seals listed in the table.

Type Codes for Bulkhead Fittings

Potting Seal Type	Fitting Material	
	Brass	Stainless Steel
Low Temp Epoxy	BFA	BFJ
Silicone Rubber	BFB	BFK
Hi-Temp Epoxy	BFC	BFL



Potted end seals help to protect the heater from moisture or contamination from plastic material, cleaning solvents, or oils. The fitting cavity can be sealed with various materials such as:

- BFA/BFJ Low temperature epoxy potting** — 266°F (130°C), UL rated to 194°F (90°C)
Teflon® leads internally connected, rated 392°F (200°C).
 - BFB/BFK Silicone rubber potting** — 450°F (232°C)
Silicone rubber leads internally connected, rated 392°F (200°C).
 - BFC/BFL High temperature epoxy potting** — 450°F (232°C)
Teflon® leads internally connected, rated 392°F (200°C).
- A minimum of 1/4" cold section below the bushing is required.
➤ **Standard 10" (254 mm) leads. Specify longer leads.**



Options

Cartridge Heater Mounting Flange Options

Type MFR Mounting Flange — Round

Available on HDC, HDM, and LDC cartridge heaters

Recommended for applications where excessive vibration exists and may cause the heater to back out of its mounting hole. The 16 ga. 304 SS flange is used as a means of securing the cartridge heater in place.

The default position of the flange is flush with the lead end. Specify the position of the flange when ordering.



Available through the Hi-Density Cartridge Heater Terminator Program for Same or Next Day Shipping with flush flange only

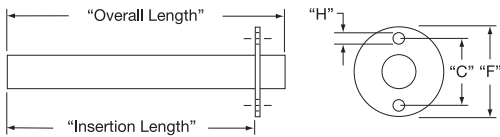

Standard Round Mounting Flanges

Heater Diameter in (mm)	"F"		"C"		"H"	
	in	mm	in	mm	in	mm
1/4 (6.35), 5/16 (7.94), 3/8 (9.53), 1/2 (12.70), 5/8 (15.88), 3/4 (19.05)	1-1/2	38.10	1-1/8	28.57	.156	3.97
7/8 (22.23), 1 (25.40), 1-1/4 (31.80)	2	50.80	1-5/8	41.28	.203	5.16



Note: 5/16" dia. cartridge heater can only be HDC; 7/8" and 1-1/4" can only be LDC.

Type MFH Mounting Flange — Hex

Available on HDC, HDM, and LDC cartridge heaters

A hex shape allows the possibility of using a wrench when removal is tight. The 16 ga. 304 SS flange is used as a means of securing the cartridge heater in place.

The default position of the flange is flush with the lead end. Specify the position of the flange when ordering.

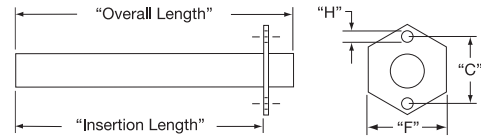

Standard Hex Mounting Flanges

Heater Diameter		"F"		"C"		"H"	
in	mm	in	mm	in	mm	in	mm
1/4	6.35	1	25.40	3/4	19.05	.144	3.66
5/16	7.94	1	25.40	3/4	19.05	.144	3.66
3/8	9.53	1	25.40	3/4	19.05	.144	3.66
1/2	12.70	1-3/8	34.93	1-5/32	29.37	.187	4.76
5/8	15.88	1-3/8	34.93	1-5/32	29.37	.187	4.76
3/4	19.05	1-3/8	34.93	1-5/32	29.37	.187	4.76
7/8	22.26	1-7/8	47.63	1-9/16	39.69	.203	5.16
1	25.40	1-7/8	47.63	1-9/16	39.69	.203	5.16
1-1/4	31.80	1-7/8	47.63	1-11/16	42.86	.203	5.16

Custom Mounting Flanges available upon request. Consult Tempco with your requirements.

Cartridge Heater Lead Wire with Strain Relief Options



Type S3 Lead Wire Strain Relief

Available on HDC, HDM, and LDC cartridge heaters

Strain relief clip for leads subject to tension and stress. A "T" type strain relief is silver brazed to the sheath.



Type S4 Right-Angle Lead Wire Strain Relief

Available on HDC, HDM, and LDC cartridge heaters

Strain relief clip for leads subject to tension and stress. A "T" type strain relief is silver brazed to the sheath and bent at a 90° angle



Cartridge Heater Option — Angled Sheath

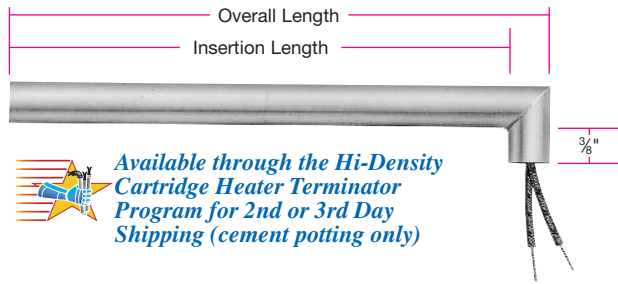

Type R3 Angled Sheath Extension

Available on HDC, HDM, and LDC cartridge heaters

The sheath extension is silver brazed to the cartridge at a 90° angle. The leads are internally connected. The standard sheath extension is 3/8" long. Specify when ordering if a longer sheath extension is required. If abrasion resistance is required, armor cable or stainless steel wire braid can be attached to the sheath extension. Available with various lead wire types and potted end seals.

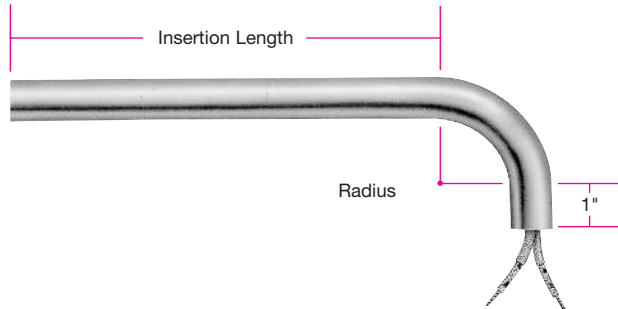

Type R4 Bent Cartridge

Available on HDC and HDM cartridge heaters

The heater sheath itself is bent to 90°. The bend is through a required cold section. The standard sheath extension past the bend is 1". Specify when ordering if a longer sheath is required.

Cartridge Dia.	in	1/4	3/8	1/2	5/8	3/4	1
	mm	6.35	9.53	12.70	15.88	19.05	25.40
Bend Radius	in	1/2	1/2	3/4	1	1-1/4	1-1/2
	mm	12.70	12.70	19.05	25.40	31.75	38.10

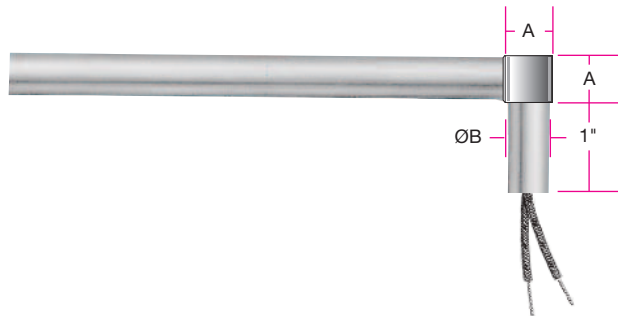

Type R5 Square Block with Tube Extension

Available on HDC, HDM, and LDC cartridge heaters

The tube extension is silver brazed or tack welded to a square S/S block. The standard tube length is 1", but different lengths can be specified. Available with various lead wire types, abrasion resistant options or potted end seals.

Heater Diameter		"A"		"B"	
in	mm	in	mm	in	mm
1/4	6.35	7/16	11.11	5/16	7.94
3/8	9.53	1/2	12.70	3/8	9.52
1/2	12.70	5/8	15.87	1/2	12.70
5/8	15.88	3/4	19.05	5/8	15.87
3/4	19.05	1	25.40	11/16	17.46

Other Sheath Options

Cartridge Heater Locating Ring

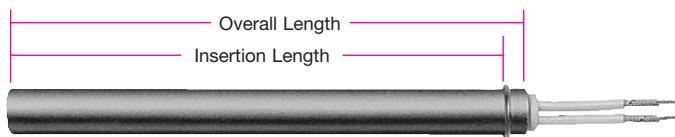

Available through the Hi-Density Cartridge Heater Terminator Program for Same or Next Day Shipping

Type LR Locating Ring

Available on HDC, HDM, and LDC cartridge heaters

A locating ring can be attached to the heater to aid in positioning the heater for the application.

The default position of the ring is 1/4" from the lead end. Specify the position of the ring when ordering.

Cartridge Heater Pull Strap



Available through the Hi-Density Cartridge Heater Terminator Program for Same or Next Day Shipping

Type PS Pull Strap

Available on HDC, HDM, and LDC cartridge heaters

A nickel wire rope is silver brazed to the lead end of the cartridge heater sheath to assist in removing the heater.



Cartridge Heater Terminal Box Options



Available through the Hi-Density Cartridge Heater Terminator Program For 2nd or 3rd Day Shipping

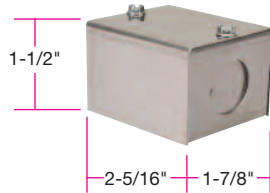

Type E1 General Purpose Terminal Box

Available on HDC, HDM, and LDC cartridge heaters

General purpose Stainless Steel NEMA 1 electrical enclosure designed to provide protection from electrical shock. The boxes have a 5/8" conduit knockout and are welded or brazed to the cartridge sheath.

➤ A termination must be specified separately.

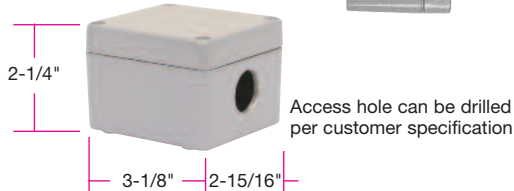

Type E2 Moisture Proof Terminal Box

Available on HDC, HDM, and LDC cartridge heaters

NEMA 4 aluminum electrical enclosures provide protection from splashing or hose directed water, external condensation and water seepage. The box is mechanically attached to the cartridge sheath.

➤ A single 5/8" access hole is standard.

➤ A termination must be specified separately.

NOTE: Potted End Seal M2C (high temperature epoxy) or M2D (low temperature epoxy) is recommended.



Type E4 General Purpose Terminal Box (mailbox style)

Available on HDC, HDM, and LDC cartridge heaters

General purpose Stainless Steel NEMA 1 electrical enclosure designed to provide protection from electrical shock. The box is welded or brazed to the cartridge sheath.

➤ A termination must be specified separately.



Type E5 Octagon Terminal Box

Available on HDC, HDM, and LDC cartridge heaters

General purpose steel NEMA 1 electrical enclosure designed to provide protection from electrical shock. The box is welded to the cartridge sheath.

➤ A termination must be specified separately.



Type E3 Explosion Resistant Terminal Box Options

Available on HDC and HDM cartridge heaters 1/2" diameter and larger.

NEMA 4/7 electrical enclosures provide protection from contaminants, moisture, and hazardous conditions. These housings are screwed onto a heater with a single or double ended Brass or Stainless Steel fitting.

- A threaded fitting mounting termination must be specified. See pages 2-50 and 2-51.
- Other terminal box configurations available upon request.

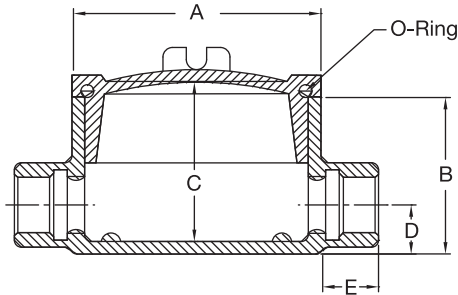

Style **E3C**



Housing E3C Dimensions

Heater Diameter(s)	Hub Size NPT	"A" (in)	"B" (in)	"C" (in)	"D" (in)	"E" (in)
1/2 & 5/8	1/2-14	2-1/2	2-1/4	2-3/16	5/8	7/8
3/4	3/4-14	2-1/2	2	2	3/4	7/8
1	1-11½	3-1/2	2-5/16	2-3/16	7/8	1

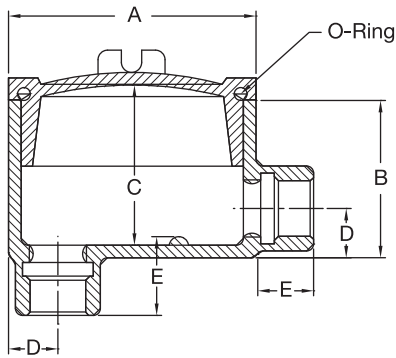

Style **E3D**



Housing E3D Dimensions

Heater Diameter(s)	Hub Size NPT	"A" (in)	"B" (in)	"C" (in)	"D" (in)	"E" (in)
1/2 & 5/8	1/2-14	2-1/2	2-1/4	2-3/16	5/8	7/8
3/4	3/4-14	2-1/2	2-1/2	2-7/16	3/4	7/8
1	1-11½	3-1/2	2-5/16	2-3/16	7/8	1

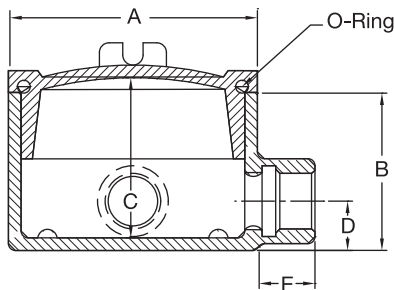

Style **E3L**



Housing E3L Dimensions

Heater Diameter(s)	Hub Size NPT	"A" (in)	"B" (in)	"C" (in)	"D" (in)	"E" (in)
1/2 & 5/8	1/2-14	2-1/2	2-1/4	2-3/16	5/8	7/8
3/4	3/4-14	2-1/2	2-1/2	2-7/16	3/4	7/8
1	1-11½	3-1/2	2-5/16	2-3/16	7/8	1



Explosion resistant terminal housings are intended to provide containment of an explosion in the enclosure only. No portion of the heater assembly outside the enclosure is covered under this NEMA rating. Abnormal use of a heater which results in excessive temperature can create hazardous conditions such as a fire. Never perform any type of service nor remove the housing cover prior to disconnecting all electrical power to the heater.

Cartridge Heaters



Lead Wire Options

Cartridge Heater Options — Lead End Connections

Type RT Ring Terminal

Type ST Spade Terminal

Type QTA 1/4" Female Straight Quick Disconnect

Type QTB 1/4" Female Right-Angle Quick Disconnect

Available on HDC, HDM and LDC cartridge heaters

Various types of crimp terminals can be attached to the heater leads to make wiring into applications quick and easy. Non-insulated and insulated with nylon (221°F/105°C) or PVC (194°F/90°C).



Note: Specify insulation type and ring size (#6, #8, or #10) when ordering. Standard is a non-insulated #10 terminal. Consult Tempco with your requirements.



Type RT



Type ST



Type QTA



Type QTB

Type P Quick Disconnect Plugs

Available on HDC, HDM, and LDC cartridge heaters

Allows for the quick and easy replacement of the heater. The plug can be attached to galvanized armor cable, stainless steel armor cable, or wire braid.

Plug Type

Description

- | | |
|----------|---|
| 1 | 2-pole/2-wire twist locking plug, 15 amp 125 volt
NEMA L1-15P (Part Number EHD-102-102) |
| 2 | 2-pole/3-wire twist locking plug, 15 amp 125 volt or
10 amp 250 volt
NEMA N/A. (Part Number EHD-102-107)
NOTE: This plug is not listed by UL, and is recommended
for replacement use only. |
| 3 | 2-pole/3-wire straight blade plug, 15 amp 125 volt
NEMA 5-15P (Part Number EHD-102-103) |
| 4 | 2-pole/3-wire twist locking plug, 15 amp 125 volt
NEMA L5-15P (Part Number EHD-102-113) |
| 5 | 2-pole/3-wire twist locking plug, 15 amp 250 volt
NEMA L6-15P (Part Number EHD-102-121) |
| 6 | 2-pole/3-wire twist locking plug, 20 amp 250 volt
NEMA L6-20P (Part Number EHD-102-122) |
| 8 | 2-pole/3-wire straight blade plug, 15 amp 250 volt
NEMA 6-15P (Part Number EHD-102-114) |
| 9 | 2-pole/3-wire twist locking plug, 20 amp 250 volt
NEMA L2-20P (Part Number EHD-102-104)
NOTE: For other types of plugs, consult Tempco or
specify the manufacturer's part number when ordering.
See page 15-15 for additional information. |

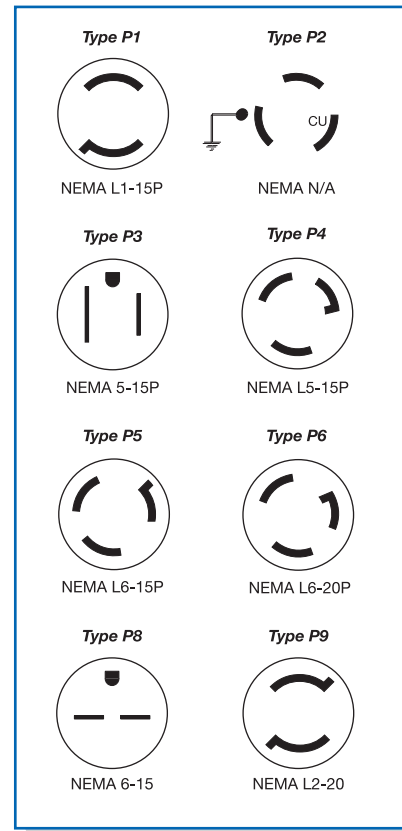

Caution! Voltage and Amperage ratings of heater and plug must match.



Available through the Hi-Density Cartridge Heater Terminator Program for Same or Next Day Shipping



Cartridge Heater Lead Wire Options

Type MIL High Temperature Lead Wire

Available on HDC, HDM and LDC cartridge heaters

When required, high temperature lead wire can be used on most cartridge heaters. The stranded wire is insulated with mica tapes and then a treated fiberglass overbraid.

- Maximum temperature rating: 450°C (842°F)

Type TL Teflon® Leads

Available on HDC and HDM cartridge heaters

- Maximum temperature rating: 200°C (392°F)

Type HA Heat Shrink Covered Armor Cables

Available on HDC, HDM and LDC cartridge heaters

- Either the galvanized or stainless steel armor cable can be covered with moisture proof heat shrink PVC tubing.

Type HTL Very High Temperature Lead Wire

Available on HDC, HDM and LDC cartridge heaters

When required, high temperature lead wire can be used on most cartridge heaters. The stranded wire is insulated with mica composite and then a treated fiberglass overbraid.

- Available wire gauge sizes: 10-18
- Maximum temperature rating: 550°C (1022°F)

Type SR Silicone Rubber Coated Fiberglass Sleeving

Available on HDC, HDM and LDC cartridge heaters

For added protection, strength, and resistance to various chemicals, the lead wires can be covered with silicone rubber sleeving.

SRA Silicone rubber coated fiberglass sleeving on each lead separately

SRB Silicone rubber coated fiberglass sleeving on both leads together

- Specify length when ordering.
- Maximum temperature rating: 200°C (392°F)

*Consult Tempco with your requirements.
We welcome your inquiries.*

Cartridge Heater Options — Sheath Surface and Sheath Material

Type IS Incoloy® Sheath

Available on HDC and HDM cartridge heaters.

The standard sheath material for all Hi-Density Cartridge Heaters except 1" diameter is 321 stainless steel; standard for 1" diameter is 304 stainless steel. The incoloy sheath option is available on all diameters except 1/8", 5/16", 8 mm and 20 mm.

To assist you in selecting the proper sheath material, corrosion resistant ratings and chemical properties of various heater sheath materials are given in Section 16, Engineering Data, in the back of this catalog.

Type DSM Other Special Sheath Materials

If your application requires a specific alloy sheath material other than described in Type IS above, consult Tempco with your requirements.

Type PAS Passivation

Available on HDC, HDM, and LDC cartridge heaters.

Passivating is a chemical process accomplished by dipping the heater in a solution of nitric acid. The process removes surface contamination, usually iron, so that the optimum corrosion resistance of the stainless steel is maintained.

Type OAL Special Length Tolerance

Available on HDC, HDM, and LDC cartridge heaters.

If a special length tolerance different than the standard length tolerance specified on page 2-4 is required, consult Tempco with your requirements.

Type ELP Electro-Polish

Available on HDC, HDM, and LDC cartridge heaters.

Electro-Polishing is an electro-chemical process that removes surface imperfections and contaminants, enhancing the corrosion resisting ability of the heater sheath.

Type CG Centerless Grinding

Available on HDC and HDM cartridge heaters.

For applications requiring high precision fit and tolerance, the sheath can be centerless ground.

Tolerance: ± 0.0005 inches (0.013 mm)

Specify diameter when ordering.

Type SDA End Disc Seals Silver Brazed

Type SDB End Disc Seals Heli-Arc Welded

Available on LDC cartridge heaters.

End discs on HDC and HDM cartridge heaters are heli-arc welded as standard.

The normally mechanically attached end discs on LD cartridge heaters can be silver brazed or heli-arc welded if desired.



Cartridge Heater With Built-In Internal Thermocouples

Built-in Internal Thermocouples are available on all HDC, HDM, and LDC cartridge heater diameters except for 3/16", 5/16" and 8 mm.



Notes: Type TJ4 and TK4 are not available on 1/4" and 6.5 mm diameter cartridges.

Minimum sheath length: 3" for 1/4", 3/8" and 1/2" diameter. 4" for 5/8" and 3/4" diameter.

10" leads are standard for both heater and thermocouple. Leads are internally connected. Specify longer leads.

ANSI Code	Conductor Characteristics		Temperature Range	
	Positive	Negative	°F	°C
J	Iron (Magnetic)	Constantan (Non-Magnetic)	0 to 1400	-17 to 760
K	Chromel (Non-Magnetic)	Alumel (Magnetic)	0 to 2300	-17 to 1260

For other thermocouple types consult Tempco.

Type TJ1 and TK1



Type TJ1 and TK1 Grounded at Disc End

The thermocouple junction is grounded to the sheath at the disc end and packed with MgO. The concave end disc is filled with silver solder and ground flat. When inserted into a flat end blind hole, it will provide fast responsive temperature readings. Widely used in Hot Runner mold probes.

TJ1 Type J thermocouple; **TK1** Type K thermocouple

Type TJ2 and TK2



Type TJ2 and TK2 Ungrounded at Disc End

The thermocouple junction is ungrounded, located at the end of the heater section, 1/8" behind the end disc and packed with MgO. Only provides reference temperature reading of the part being heated – slower response.

TJ2 Type J thermocouple; **TK2** Type K thermocouple

Type TJ3 and TK3



Type TJ3 and TK3 Ungrounded at Center

The thermocouple junction is ungrounded and is located in the center of the length and diameter of the cartridge heater. It provides internal temperature readings of the heater core. Generally used for research applications and is not recommended for controlling process temperatures.

TJ3 Type J thermocouple; **TK3** Type K thermocouple

Type TJ4 and TK4



Type TJ4 and TK4 Grounded at Center

The thermocouple junction is grounded to the sheath in a 1/2" unheated section located in the center of the cartridge length unless otherwise specified. It provides good temperature readings with quick response.

TJ4 Type J thermocouple; **TK4** Type K thermocouple

Type TJ5 and TK5



Type TJ5 and TK5 Grounded at Lead End

The thermocouple junction is grounded to the sheath at the lead end. A minimum of 3/8" of cold section is required. It provides good temperature readings with quick response.

TJ5 Type J thermocouple; **TK5** Type K thermocouple



Note: For a complete selection of standard Hi-Density Pennybottom™ Cartridge Heaters, with built-in Type J thermocouple for Hot Runner plastic molds, see pages 2-24 through 2-26.

Available from stock.



Cartridge Heater Options — Internal Power Variations



Type DW Distributed Wattage

Available on HDC and HDM cartridge heaters

Cartridge heaters can be designed to vary the wattage along the length of the heater. Specify number of zones and the required watts and length per zone starting from the disk end. Leads can be connected externally or internally. Picture shows a heater with Type N externally connected leads. Heaters with other terminations may require a longer cold section at the lead end.

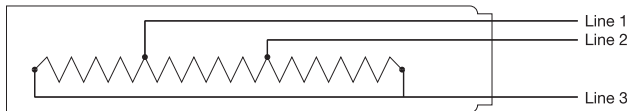

Type 3PH Three Phase

Available on HDC, HDM, and LDC cartridge heaters 1/2" diameter and larger (See page 2-4)

In order to minimize the gauge of the wiring on high wattage cartridge heaters, 3-phase elements can be designed.

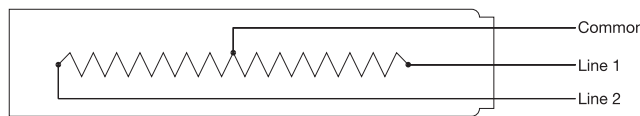

Type DV Dual Voltage

Available on HDC, HDM, and LDC cartridge heaters 3/8" diameter and larger (See page 2-4) 3/8" and 1/2" diameter heaters may require a larger diameter transition area at lead end.

Cartridge heaters can be designed using 3-wire series/parallel circuits for dual voltage applications. Whether the heater is run on the high or low voltage, the wattage will be the same.

DV1 120/240 volts **DV2** 240/480 volts

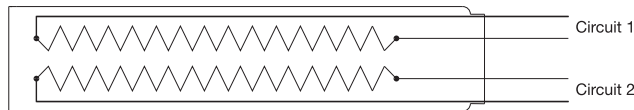

Type DWV Dual Circuits

Available on HDC, HDM, and LDC cartridge heaters 1/2" diameter and larger (See page 2-4)

Independent resistance elements can be designed in a single cartridge heater for added versatility.

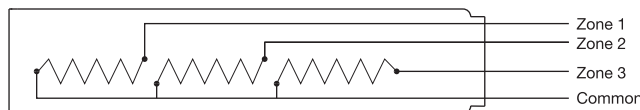

Type MHZ Multiple Heat Zones (3-Zones Maximum)

Available on HDC and HDM cartridge heaters 3/8" diameter and larger (See page 2-4) 3/8" and 1/2" diameter heaters may require a larger diameter transition area at lead end.

Multiple independently operated sections of the heater with a common wiring connection can be designed for increased flexibility.

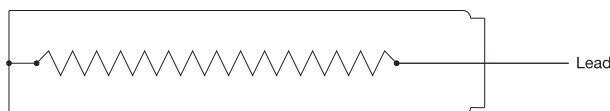

Type GJ Grounded Element Winding

Available on HDC, HDM, and LDC cartridge heaters

For DC applications where the electrical circuit is negative grounded, the cartridge heater can be designed with one side of the element winding grounded to the sheath and a single lead wire exiting the cartridge heater.

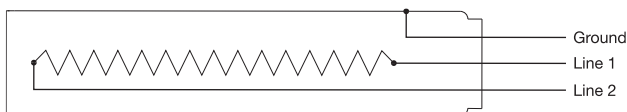

Type GL Ground Lead/Sheath

Available on HDC, HDM, and LDC cartridge heaters

For those applications requiring a separate ground lead attached to the cartridge heater sheath.

Standard ground lead wire is a 10" long insulated stranded conductor. Optional insulated and color coded leads are available.

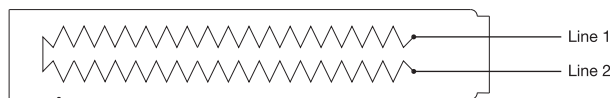

Type LLC Low Leakage Current

Available on HDC, HDM, and LDC cartridge heaters

Low leakage current construction is available for those applications such as medical products that require strict conformity to the requirements of regulatory agencies.



Available through the Hi-Density Cartridge Heater Terminator Program for 2nd Day Delivery



Options

Cartridge Heater Internal Sensor and Control Options

Type TF Thermal Fuses

Available on HDC, HDM, and LDC cartridge heaters 1/2" diameter and larger

Thermal fuses can be built into cartridge heaters to act as a high limit for the heater in applications where the temperature must be limited to avoid dangerous situations. When the trigger point is reached, the thermal fuse will open, cutting the electrical current to the cartridge heater. Once the thermal fuse opens, it cannot be reset. Many different trigger temperatures are available.

Type TS Thermostat

Available on HDC, HDM, and LDC cartridge heaters 5/8" diameter or larger

Cartridge heaters with built-in thermostats are very efficient and economical for heating and controlling temperatures. Available with NPT or special type mounting fittings, they provide a self-contained heater mainly recommended for immersion applications. They can also be used as over-temperature safety devices. The thermostats are factory preset for the trip temperature; therefore, prototyping and testing is required to determine the exact fixed setpoint. Maximum temperature—302°F (150°C). Maximum Amps—8@120 Volts.

A minimum 2-1/2" cold section is required to house the thermostat. Consult Tempco with your requirements.

Type TM Thermistor

Type RD RTD Temperature Sensors

Available on HDC, HDM, and LDC cartridge heaters

Tempco has the ability to custom design cartridge heaters with built-in temperature sensors such as thermistors and RTDs. For specific applications that have a limited or single set point range, thermistors or RTDs in conjunction with simple electronic controllers can be an economical choice.

NOTE: For thermocouples see page 2-58.

Type TS

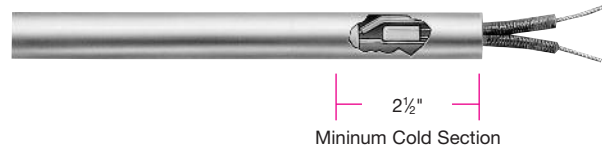

Cartridge Heater Option — Inspection Services and Test Reports

Standard Electrical Tests and Optional Test Reports

1. Resistance test — measures ohms at room temperature.
2. IR (insulation resistance) test — measures the insulation resistance to the flow of current. Standard test is done at 500VDC.
3. Hipot (high potential) test — a high voltage is applied between a product's current carrying conductors and its metallic enclosure to verify that the insulation is sufficient to protect the operator from electrical shock.
4. Leakage current test — measures the current that flows from any conductive part to ground.
5. Heaters can be serialized and test reports can be sent with each shipment if required. Contact Tempco with your requirements.

Optional Die Penetrant Test

This non-destructive testing can detect imperfections in weld joints. For critical applications, each individual heater's weld joints by end cap and fittings can be tested. Certified test reports will be sent with each shipment. Consult Tempco for details.

Optional Hydrostatic Pressure Test

Cartridge heaters with attached pipe fittings can be pressure tested to your specifications at Tempco. Our in-house testing capabilities can ensure that your products meet your exact specifications. Contact Tempco with your requirements.