

Dalton

Watt-Flex® Cartridge Heaters



**From the Leader in Cartridge Heater Technology...
...A Unique Split-Sheath Design
That Reduces the Cost of Process Heating**

Maximized Heat Transfer

● The unique split-sheath design of the Watt-Flex® Cartridge Heater allows the independent, bilateral expansion of each half of the heater outward against the walls of the surrounding bore. Maximized metal-to-metal contact results in greatly improved heat transfer under normal fit conditions of .005" to .007". The thermal expansion of conventional cartridge heaters limits heater contact to only one side of the bore (Figure 1). The unique split-sheath expansion of Watt-Flex heaters assures superior heat transfer, more uniform process heat, greater efficiency, and reduced consumption of electricity.

Figure 1: Watt-Flex Expansion Comparison

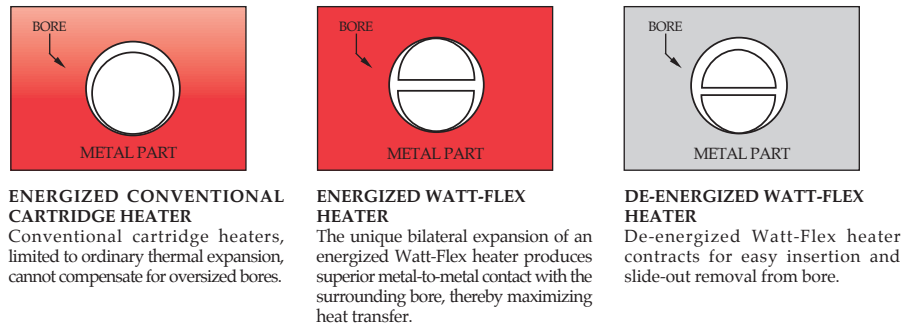

Use in Oversized Bores

● The fit of a cartridge heater is measured as the difference between the inside diameter (I.D.) of the bore and the outside diameter (O.D.) of the heater. The suggested fit for a Watt-Flex Cartridge Heater is .007" greater than the standard diameters shown on Page 4.

For example, the ideal bore diameter for a 1/2" diameter Watt-Flex heater would be 0.502" to 0.505". At the maximum tolerance dimension of the heater and the minimum bore diameter, the heater would have 0.005" fit, allowing ease of insertion and removal. Generally, smaller diameter heaters benefit from a bit tighter fit and fit can be slightly loosened for larger diameters.

The unique expanding action of Watt-Flex heaters eliminates the need for tight fits. This makes Watt-Flex heaters ideal for use in oversized bores. Superior bilateral expansion permits the use of Watt-Flex heaters in bores where conventional heaters could not be used effectively.

Figure 2: Thermal Expansion Comparison

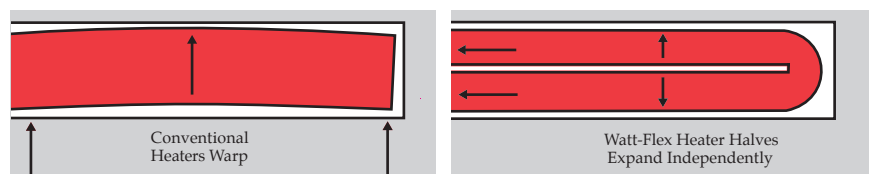

Ease of Removability

● Dalton Electric will replace, free of charge, any Watt-Flex Cartridge Heater that cannot be withdrawn from the bore.

Dalton Electric's standard product warranty covers the removal of Watt-Flex heaters from bores, providing the bore fit is a minimum of .005" and there is no bore contamination to cause seizure. This warranty is possible because the split-sheath design of Watt-Flex heaters eliminates warping, the primary cause of bore seizure in heating applications.

As shown in Figure 2, temperature differentials exist from one side of conventional cylindrically sheathed cartridge heaters to the other. These differentials occur because only one side of the heater comes in contact with the bore. The resulting deflection within a close-fitting bore often makes the heater bind during removal. With the Watt-Flex heater's split-sheath design, each half of the heater contracts independently when de-energized to provide ease of removability.

Higher Watt Densities and Temperatures

Longer Life

• The Watt-Flex Cartridge Heater is essentially a tubular heater bent back on itself and swaged into a cylindrical format. Unlike conventional heaters, Watt-Flex heaters have no ceramic core which can crack during swaging, therefore, they can be compacted to a much greater density. This process increases both heat transfer ability and insulative value of the dielectric.

The greater insulation value accommodates significantly higher watt-densities. In fact, Watt-Flex heaters produce up to 50% higher warrantable watt-densities than conventional heaters and can operate at much higher temperatures.

• The life of a cartridge heater is directly related to its internal operating temperature. Denser and more uniform compaction of the dielectric provides greater heat transfer to the Watt-Flex sheath. This, combined with more efficient heat transfer to the surrounding metal through intimate contact with the wall of the bore, permits the Watt-Flex resistance coil to run substantially cooler than conventional cartridge heater coils. The result is up to five times longer life, decreased downtime, and lower operating costs.

Figure 3: Watt-Flex® SPLIT-SHEATH CARTRIDGE HEATER

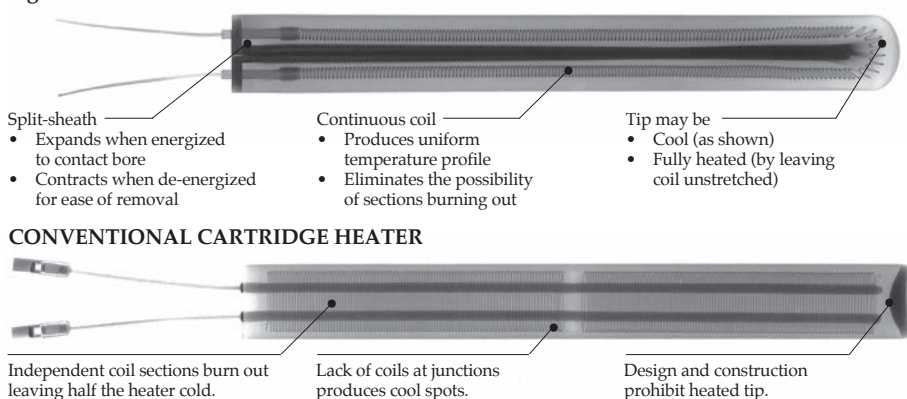

Uniform Temperature Profile

• Unlike conventional cartridge heaters, Watt-Flex heaters have a continuous heating coil for a more uniform temperature profile. Continuous coil construction eliminates the cold spots which can occur at core junctions in ceramic core heaters. (See Figure 3.) With Watt-Flex heaters there are no independent sections to burn out. Therefore, Watt-Flex heaters are either totally on or totally off. Figure 4 shows the superior temperature profile along the length of a torpedo probe heated by a Watt-Flex heater. Uniform sheath temperature is vital when molding heat-sensitive plastics where the temperature window between gate freeze-off and material degradation is very narrow.

By varying the watt-density, the temperature profile may be custom-matched to specific requirements. For example, certain applications, such as those requiring temperatures higher at the tip of a molding probe than along the sheath, can be accomplished with Watt-Flex heaters but not with conventional cartridge heaters.

Figure 4: Superior Temperature Distribution Based on Actual In-Mold Tests

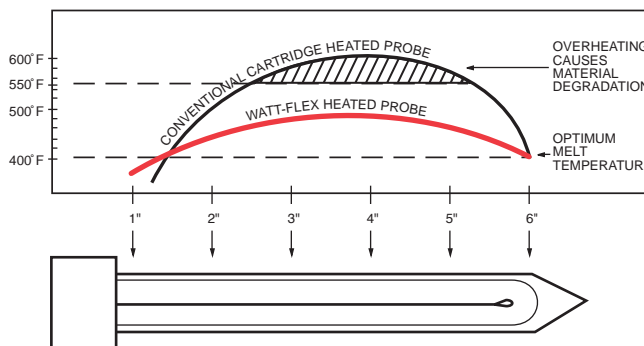

Standard Watt-Flex Heater Dimensions

AVAILABLE DIAMETERS	NOMINAL DIAMETERS ¹	STANDARD COLD SECTION AT TERMINAL END	MINIMUM - MAXIMUM ² LENGTHS
1/4"	0.245"	5/16"	1 1/4" - 22"
3/8"	0.370"	3/8"	1 1/2" - 36"
1/2"	0.495"	5/8"	2" - 50"
5/8"	0.620"	5/8"	2 1/2" - 70"
11/16"	0.683"	5/8"	3 1/2" - 64"
3/4"	0.745"	5/8"	3 1/2" - 90"
1"	0.9925"	1"	8" - 60"
8.0 mm	7.875 mm	8.000 mm	38 mm - 660 mm
10.0 mm	9.875 mm	9.500 mm	38 mm - 915 mm
12.0 mm	11.875 mm	15.875 mm	50 mm - 1140 mm
12.5 mm	12.375 mm	15.875 mm	50 mm - 1140 mm
15.0 mm	14.875 mm	15.875 mm	65 mm - 1250 mm
16.0 mm	15.875 mm	15.875 mm	65 mm - 1775 mm
20.0 mm	19.875 mm	15.875 mm	100 mm - 1525 mm

1) Tolerance: ±.002" (1/4"-3/4"); ±.0025" (1")
±.05 mm (8 mm - 20 mm)

2) Tolerance: ±3% with 3/32" minimum
±2% above 20" (500 mm)

Hot Tip Option

Watt-Flex heaters can be constructed to generate full heat at the tip (Figure 5). When selected for injection molding gate probes, the hot tip feature minimizes undesirable gate freeze-off.

Figure 5: Watt-Flex Hot Tip Heater vs. Conventional Heater



Conventional cartridge heater construction prohibits a heated tip.



Only Watt-Flex heaters are designed with a continuous coil that delivers full heat to the tip.

Exclusive External Thermocouple Option

Watt-Flex heaters can be manufactured with a groove along the exterior of the cartridge to accommodate a needle-type thermocouple (Figure 6) for more accurate temperature sensing and control. Unlike cartridge heaters with internal thermocouples which measure the internal coil temperature, Watt-Flex heaters measure the temperature at the point of heat transfer from the heater to the host metal.

Another feature of this design is that the temperature can be monitored at any point along the heater, unlike internal thermocouples with fixed positions. And, the Watt-Flex design allows for independent replacement of the heater or the thermocouple, without having to discard an operational component as in conventional designs.

The maximum lengths for grooved heaters are 15" for 1/4" and 3/8" diameter heaters and 7" for 1/2" diameter heaters. Longer heaters, 1/2" diameter or larger, can be center grooved between the legs to a depth of 6". Thermocouples are Type J with a lead length of 48". A 0.040" needle diameter is used for 1/4" diameter heaters and all center grooved. A 0.062" needle diameter is used for side grooved 3/8" and 1/2" diameter heaters.

Figure 6: Watt-Flex Heater with Optional Thermocouple

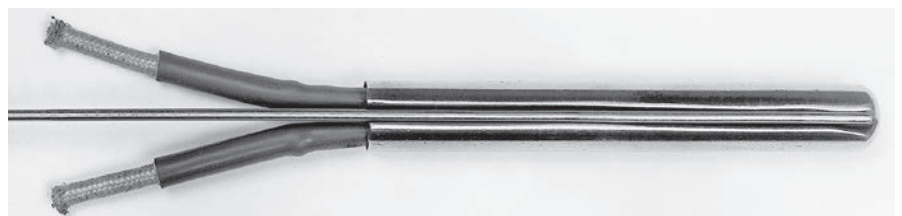

Heater Accessories

Watt-Flex heaters are available with a variety of options including abrasion resistance, moisture resistance, mounting variations, high-temperature modifications, and lead modifications. The illustrations below show a sampling of the accessories available.

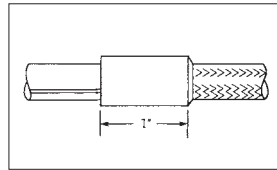

STRAIGHT HEADER WITH STAINLESS STEEL BRAID

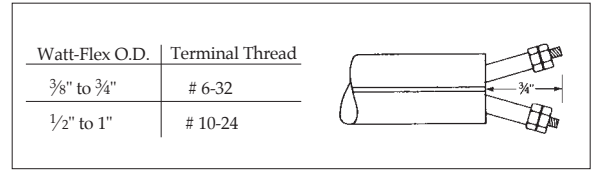

THREADED POST TERMINALS

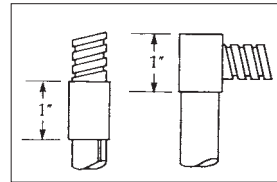

STRAIGHT OR RIGHT ANGLE HEADER WITH STAINLESS STEEL FLEXIBLE HOSE

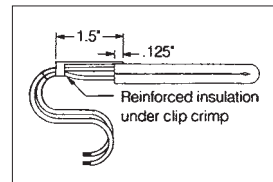

STAINLESS STEEL CLIP SUPPORT USED AS AN ANTIFLEX DEVICE—90° ANGLE AVAILABLE

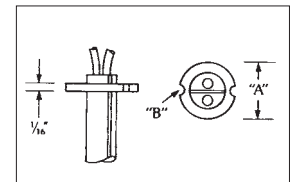

STAINLESS STEEL MOUNTING FLANGE

HEADER TYPE	Watt-Flex O.D.	HEADER O.D.	HOSE O.D.	Watt-Flex O.D.	"A"	"B" MOUNTING
Straight or Right Angle	1/4"	3/8"	11/32"	1/4"	1"	.080" R on 1" BC
	3/8"	1/2"	11/32"*	3/8"	1"	.080" R on 1" BC
	1/2"	5/8"	1/2"	1/2"	1"	.080" R on 1" BC
	5/8"	3/4"	1/2"	5/8"	1"	.080" R on 1" BC
	3/4"	7/8"	1/2"	3/4"	1 1/2"	.160" D on 1 1/4" BC
	1"	1 1/8"	5/8"	1"	2"	.201" D on 1 1/2" BC

* 3/8" Diameter Right Angle Header with High-Temperature Leads has 1/2" Hose O.D.

The following accessories are available on Watt-Flex heaters. Please consult factory for special accessories or designs.

- Abrasion Protection**
 - Stainless Steel Braid
 - Stainless Steel Flexible Hose
 - Straight or Right Angle Headers
- Contaminant Protection**
 - RTV Potting
 - Ceramic Potting
- Mounting Variations**
 - Stainless Steel Flange
 - Puller End Plug
 - Mounting Bracket
 - NPT Fitting
- High-Temperature Modifications**
 - High-Temperature Leads
 - Extra Cold Section at Terminal End
 - Ceramic Beads
- Lead Modifications**
 - Extra Length Leads
 - Threaded Post Terminals
 - Fiberglass or Silicon Rubber Sleeving
 - Quick Disconnect
 - Clip Support
 - Integral Ground Wire

Ordering Information

When ordering Watt-Flex heaters, please specify:

- Quantity
- Standard or grooved sheath
- Sheath diameter
- Sheath length
- Wattage
- Voltage
- Hot or cool tip
- Lead wire length
- Any accessories
- Preassigned part number (if available)
- Severe ambient conditions (such as dripping oil)
- Manufacturing process and set point temperature
- Bore inside diameter (if heater is to be used in bore)
- Frequency of cycling (if heater will be regulated by controller)
- Severe lead wire flexing (if applicable)

Dalton reserves the right to ship 90-110% of quantity ordered (for quantities of 10 or less, ±1 heater).

Engineering Data and Design Considerations

Heating Metal Parts

The following information is provided to assist you in the selection of Watt-Flex heaters and the design of new heating equipment in which they will be used. Dalton engineers are available for consultation on any heating application. Please call if you have questions or would like additional assistance.

The following equations will assist you in determining the heater capacity needed to produce a required level of heat. (Refer to "Physical Properties of Materials" charts below for values needed for calculations.)

Calculation of Required Wattage

A) WATTS FOR MATERIAL HEAT-UP =

$$\frac{\text{Weight of Material (lbs)} \times \text{Specific Heat} \times \text{Temp. Rise (°F)}}{3.412 \times \text{Heat-Up Time (hours)}}$$

B) WATTS HEAT LOSS DURING HEAT-UP =
Watt Loss per sq. in. * Area (sq. in.)

C) TOTAL WATTS REQUIRED = (A + B) X 1.2
(20% safety factor for contingencies)

** Consult graph for applicable wattage loss rates.

WATTAGE LOSS RATES

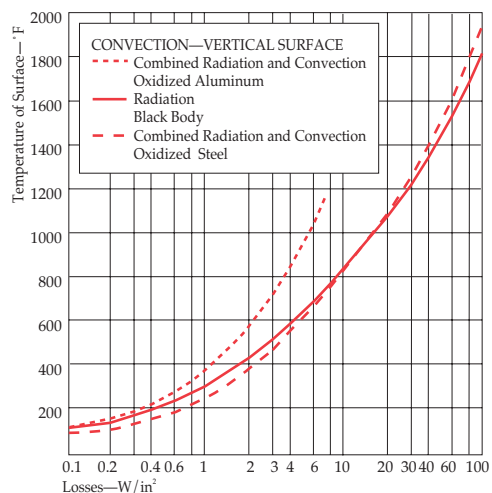

Physical Properties of Materials

Substance	Specific Heat	Heat of Fusion	Lowest Melting Point	Density		Thermal Conductivity	Thermal Expansion
	Btu/lb °F	Btu/lb	°F	lb/ft³	lb/in³	Btu/hr/ft²/°F/ft	inches per inch per °F x 10 ⁻⁶
Aluminum 1100	.24	169	1190	169	.098	128	13.1
Aluminum 2024	.24	167	935	173	.100	112	12.9
Aluminum 3003	.24	167	1190	170	.099	112	12.9
Antimony	.052	69	1166	423	.245	10.9	4.7 - 6.0
Brass (70% Cu, 30% Zn)	.10	-	1700±	525	.304	56	11.1
Carbon	.204	-	6700	-	.080	13.8	.3 - 2.4
Copper	.10	91	1981	550	.318	224	9.2
Glass	.20	-	2200±	165	.096	.45	5
Graphite	.20	-	-	130	.075	.104	-
Incoloy 800	.12	-	2475	501	.290	8.1	7.9
Inconel 600	.11	-	2470	525	.304	9.1	7.4
Invar	.13	-	2600	508	.294	6.1	0.6
Iron, cast	.13	-	2300±	450	.260	33	6.5
Iron, wrought	.12	-	2800±	480	.278	36	6.5
Lead, solid	.031	10	621	710	.411	20	16.3
Lead, melted	.04	-	-	665	.385	-	-
Magnesium	.232	160	1202	109	.063	91	14
Monel 400	.11	-	2370	551	.319	14	7.7
Nickel 200	.11	133	2615	554	.321	39	7.4
Nichrome (80% Ni, 20% Cr)	.11	-	2550	524	.303	8.7	7.3
Solder (50% Pb, 50% Sn)	.04	17	415	580	.336	26	13.1
Steel, mild carbon	.12	-	2550±	490	.284	38	6.7
Steel, stainless 304	.11	-	2550	488	.282	8.8	9.6
Steel, stainless 430	.11	-	2650	475	.275	12.5	6.0
Tin, solid	.056	25	450	455	.263	36	13
Tin, melted	.064	-	-	437	.253	18	-
Type metal (85% Pb, 15% Sb)	.040	15	500	670	.388	-	-
Zinc	.095	51	787	445	.258	65	9.4 - 22

Heating Liquids

Consideration should be given to the following factors when heating liquids with Watt-Flex Cartridge Heaters:

- Locate heater wells in an unrestricted space in the main body of the liquid.
- The heated section of the well should be covered by liquid at all times.
- In metal-melting applications, explosions can result if pressure is not vented during the melting phase of heat-up.
- Certain watt-density limits exist in immersion applications. Please consult the factory for additional assistance.

Watt-Flex[®] Replaceable Immersion Heaters

- Stainless steel sheath accommodates standard diameter flanged Watt-Flex Cartridge Heaters.
- Easily replaced without draining the tank or vat. Watt-Flex heater contracts when de-energized for easy removal.
- Clean and safe. Heater never comes in contact with contents of tank.

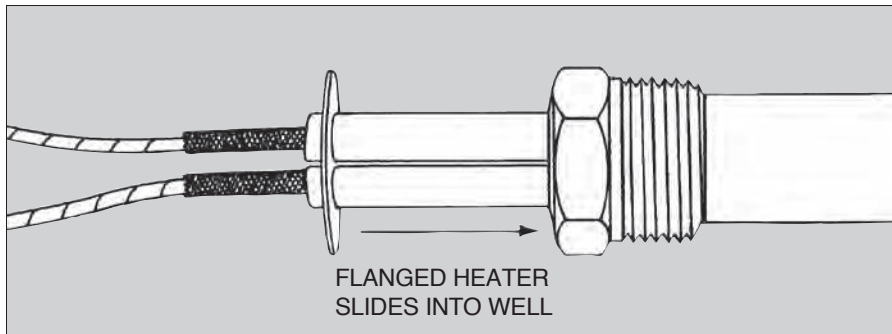

Construction

- Stainless steel sheath with a welded end cap and NPT fitting which screws into and becomes a permanent part of the tank to be heated.

Flanged Watt-Flex heater is secured to NPT fitting with two screws. To replace the heater, simply remove the screws and slide the de-energized heater out.

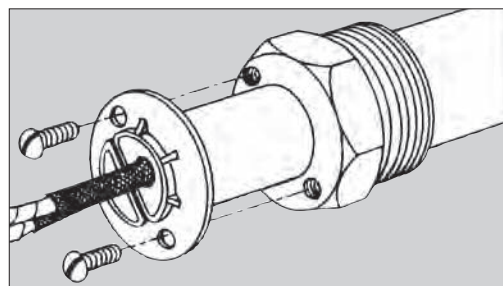

IMMERSION HEATER		CARTRIDGE HEATER	
Sheath O.D.	NPT Fitting	Diameter	Length (Min. - Max.)
5/8"	3/4"	12.5 mm	5" - 45"
7/8"	1"	3/4"	8" - 72"

NOTE: Both Watt-Flex Immersion Heaters and Cartridge Heaters are manufactured to customer specified lengths.



Diff-Therm™ Platen Heaters by Dalton

● Diff-Therm™ Platen Heaters are high-quality, tubular heating elements swaged under 50 tons per square inch of pressure into grey iron castings (platens and rings). Superior design and meticulous construction make Diff-Therm heaters the industry standard for long life, uniformly distributed process heat, and efficient power generation.

Over 100 heater combinations of electrical ratings and casting sizes are available for 2" through 48" diffusion pumps. Diff-Therm heaters are also available in custom casting dimensions and electrical ratings for use on obsolete and foreign-made pumps.

The proven industry standard, Diff-Therm heaters offer easy heater selection, easy installation, superior process heating, and longer heater life. Standard heaters are shipped within 5 days of the receipt of an order.

Illustration 1 below shows how Diff-Therm heaters are designed to provide superior performance over other bolt-on diffusion pump heaters. Dalton Electric manufactures tubular heating elements using only high-purity magnesium oxide, nickel chrome resistance wire, and stainless steel terminals for internal components. Special filling methods and equipment compact the magnesium oxide inside and around the resistor helix to extreme density. Swaging further compacts the magnesium oxide virtually to maximum density, yielding high dielectric strength and efficient internal heat conduction. Swaging the heating elements into undercut grooves in the Diff-Therm casting locks the elements into intimate contact with the casting, and provides uniform heat conduction along the entire length of the grooves.

The surface of the Diff-Therm casting which contacts the diffusion pump boiler plate is machined to a flat, smooth finish. This process assures efficient and uniform heat conduction into the boiler plate for steady vaporization of the pump fluid (Illustration 2).

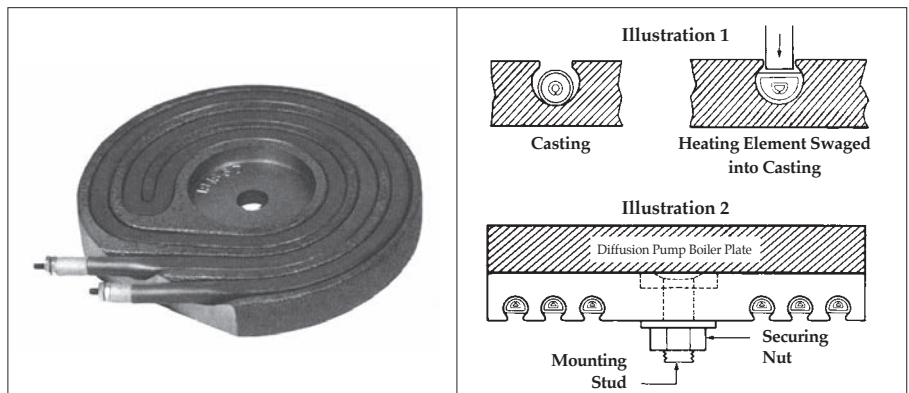

Warranty

● Dalton Electric warrants its products only against defects in materials and workmanship. Dalton Electric's liability and a customer's exclusive remedy under this or any warranty extend for the earlier of two thousand hours of operation, or one year from the date of Dalton's shipment, provided the product or products are properly stored, installed, maintained, and operated. Dalton Electric's liability is exclusively limited to repayment of the purchase price, repair or replacement, at Dalton Electric's option, during said period, upon proof satisfactory to Dalton and upon customer's returning and prepaying all charges on such products to factory or warehouse designated by Dalton Electric. THIS WARRANTY IS MADE EXPRESSLY IN LIEU OF ALL OTHER WARRANTIES, EXPRESS, IMPLIED, OR STATUTORY, WITH RESPECT TO QUALITY, MERCHANTABILITY, OR FITNESS FOR A PARTICULAR PURPOSE.