

# Strip Heaters

## **MAXISTRIP**<sup>®</sup>

**A Reliable Heat Source with  
Excellent Heat Transfer  
Capabilities Due to the  
Aluminum Shoe Construction**

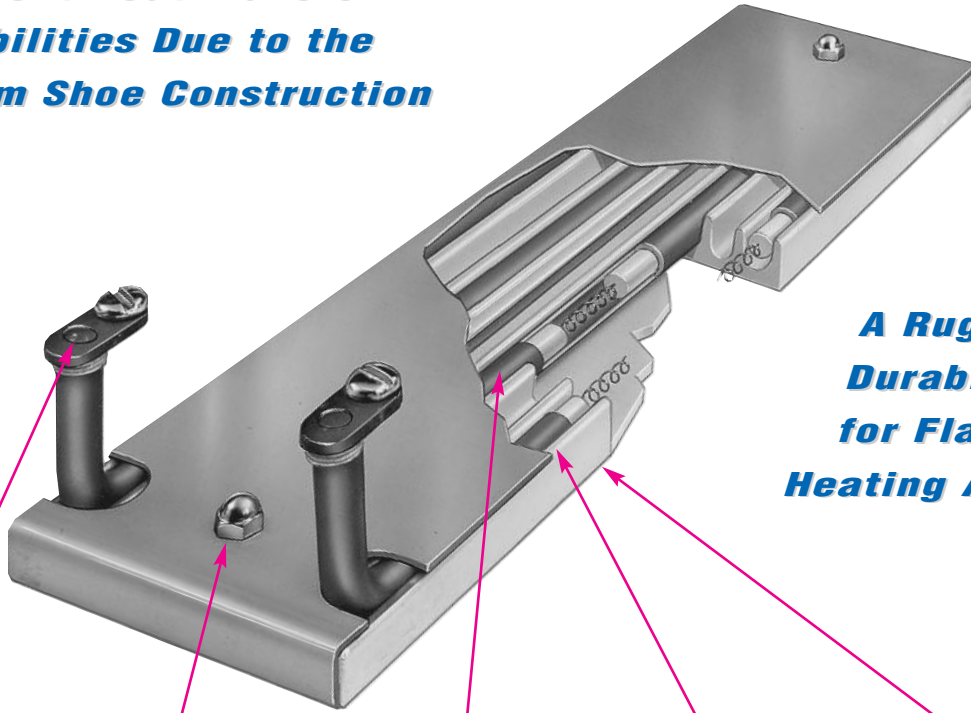

**A Rugged and  
Durable Heater  
for Flat Surface  
Heating Applications**

**A** Right-angle lug terminals with 10-32 binding head screws provide ease of electrical wiring.

**B** Crown nuts securely fasten the cover plate to the aluminum track, keeping contaminants from coming in direct contact with the tubular heating element.

**C** Ruggedly constructed .315 diameter heating elements are the heat source for Maxistrip heaters, providing excellent life and long, trouble-free service.

**D** Specially designed aluminum track houses the tubular heating element, providing an excellent heat sink for rapid heat transfer and good temperature uniformity.

**E** The surface contact on Maxistrip heaters is extremely smooth and flat, which is essential for good heat conduction. This results in exceptionally long heater life.

**TEMPCO Maxistrip Heaters** are specially designed and engineered for trouble-free performance and more efficient heating of flat surfaces. Due to the rugged construction characteristics of this type of strip heater, it is highly recommended for applications requiring excellent heat transfer and temperature uniformity.

### Design Features

- \* Quick Installation
- \* Contamination Proof
- \* Various Lead Terminations
- \* Excellent Heat Transfer
- \* Excellent Temperature Uniformity
- \* Designed for Durability and Trouble-Free Service

### Typical Applications

- ➔ Extrusion Dies
- ➔ Molds
- ➔ Hot Plates
- ➔ Drying
- ➔ Incubators
- ➔ Platens
- ➔ Sealing Bars
- ➔ Thermoforming
- ➔ Tank Heating
- ➔ Food Warmers



**Note:** Mounting holes can be provided down the center. For other locations see drawings on page 8-17.



### Specifications & Tolerances

#### Standard Specifications and Tolerances of Maxistrip Heaters.

If tighter tolerances are required, consult Tempco.

#### PERFORMANCE RATINGS

**Maximum Sheath Temperature:** 650°F (343°C)

**Maximum Watt Density:** 20 W/in<sup>2</sup> (3.1 W/cm<sup>2</sup>)

#### ELECTRICAL SPECIFICATIONS

**Maximum Voltage:** 277VAC

**Maximum Recommended Voltage w/ Leads:** 240VAC

**Maximum Watts:** Dependent on width and length

**Maximum Amperage:** 25 Amps

**Resistance Tolerance:** +10%, -5%

**Wattage Tolerance:** +5%, -10%

#### PHYSICAL SIZE CONSTRUCTION LIMITATIONS

**Widths:** 1-1/2" (38.1 mm), 2-1/2" (63.5 mm), 3" (76.2 mm), 4" (101.6 mm)

**Thickness:** 1/2" (12.7 mm)

Mounting Holes can be located only along the phantom lines between the holes shown on these drawings.

**Standard Hole Diameter:** 5/16"

**Maximum Hole Diameter:** 1/2"  
(center of width only)

#### Mounting Holes

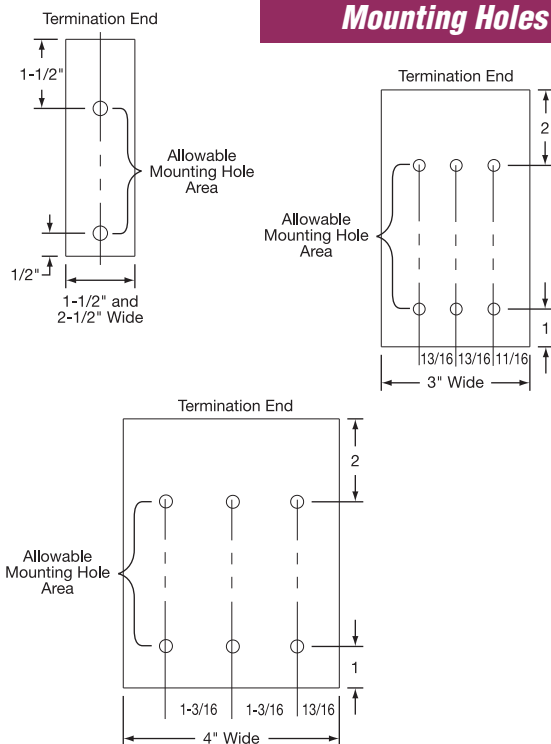

#### Screw Terminals

##### Type S Terminal Lugs

Terminal lugs with 10-32 binding head screws are the standard termination for all Maxistrip heaters.

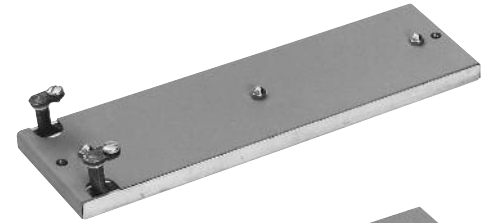

##### Type T1 Straight Terminals

Straight outward screw terminals with 8-32 threads.



##### Type R 90° Blockhead Terminals

90° Blockhead Terminals with 10-32 threads. Special design can switch between 1800W and 900W at 240V.

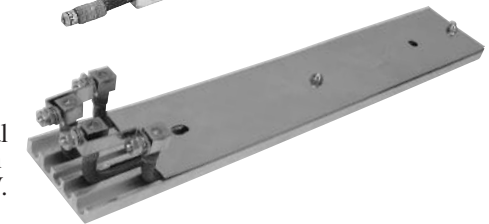

#### Abrasion Resistant Terminations

Wire braid provides strength and protection to the lead wire insulation, offering sharp bending not possible with armor cable. 20" of wire braid and 24" flexible leads are standard.

**Options:** Longer leads or braid. Male or female plugs attached to leads.

##### Type W1 Straight Wire Braid Leads

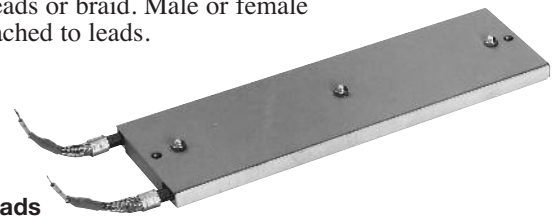

##### Type W2 Straight-Up Wire Braid Leads

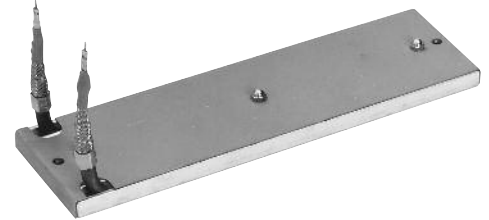

#### Special Widths



By combining one or more standard width (1-1/2", 2-1/2", 3" and 4") aluminum strip heater channels, wider surface areas can be developed. Consult Tempco with your requirements.

# Strip Heaters



## Terminations

### Abrasion Resistant Terminations

#### Type W3 Single Wire Braid Leads

Wire braid provides strength and protection to the lead wire insulation, offering sharp bending not possible with armor cable. 20" of wire braid and 24" flexible leads are standard.

**Options:** Longer leads or braid. Male or female plugs attached to leads.

#### Type R1 Single Armor Cable Leads

Armor Cable provides excellent protection against abrasion and contaminants. The cable exits through an adapter that encapsulates the element ends. The adapter and cable are silver soldered on for maximum security and seal protection. 20" of cable and 24" flexible leads are standard.

**Type R1A** Galvanized cable      **Type R1B** Stainless steel cable

**Options:** Longer leads or cable. Male or female plugs attached to leads.

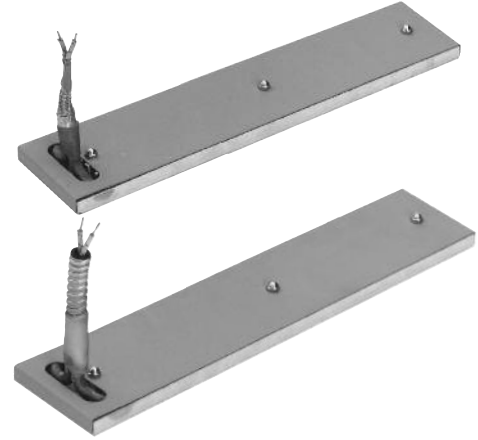

#### Type C General Purpose Stainless Steel Terminal Box

Terminal Boxes provide a simple and economical way to eliminate all live exposed terminals and electrical wiring that can be a potential hazard to employees or machines. Boxes have 1/2" trade size knockouts (actual diameter 7/8") for standard connections to simplify installation. Strip heaters fitted with boxes can be supplied factory prewired with leads, armor cable or braid.

**Type CA** Box only

**Type CB** Box with galvanized cable

**Type CC** Box with SS cable

**Type CD** Box with wire braid

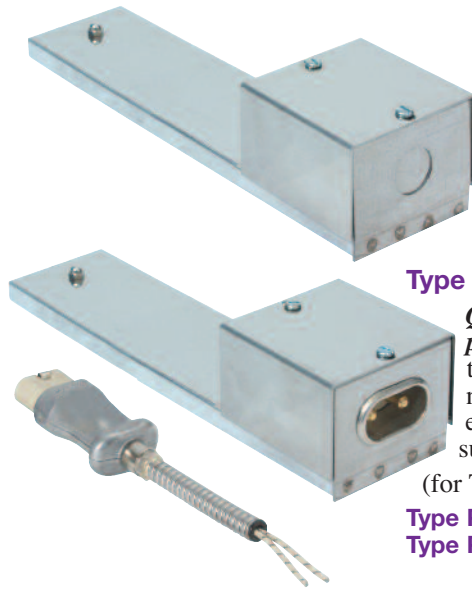

#### Type P2 Quick-Disconnect High Temperature Plug

**Quick-Disconnect Plug assemblies are highly recommended and should be used whenever possible.** They provide the simplest and safest way to apply power to strip heater installations. The combination of plug and cup assembly, along with armor cable cover leads, eliminates all live exposed terminals and electrical wiring that can be a potential hazard to employees and machines. To simplify installation, Maxistrips fitted with P2 plug assemblies can be supplied prewired, using high-temperature lead wire protected with armor cable or wire braid.

(for Type P on a 1-1/2" wide Maxistrip consult Tempco.)

**Type P2A** Box and cup only

**Type P2C** w/ straight plug and galvanized cable

**Type P2D** w/ straight plug and SS cable

**Type P2E** w/ straight plug and wire braid

### Standard (Non-Stock) Sizes and Ratings

#### Width 1-1/2" (38.1 mm)

Length in mm	Wattage	Watt Density		Part Number	
		W/in <sup>2</sup>	W/cm <sup>2</sup>	120V	240V
3 1/2	88.9	130	25 4	MXS00001	—
3 3/4	95.3	140	25 4	MXS00002	—
4	101.6	150	25 4	MXS00003	—
4 1/4	108.0	160	25 4	MXS00004	—
4 1/2	114.3	170	25 4	MXS00005	—
4 3/4	120.7	180	25 4	MXS00006	—
5	127.0	190	25 4	MXS00007	—
5	127.0	150	20 3	MXS00008	—
5 1/2	133.4	200	25 4	MXS00009	—
5 1/2	139.7	205	25 4	MXS00010	—
5 3/4	146.1	215	25 4	MXS00011	—
6	152.4	225	25 4	MXS00012	—
6 1/4	158.8	230	25 4	MXS00013	—
6 1/2	165.1	240	25 4	MXS00014	—
6 3/4	171.5	250	25 4	MXS00015	—
7	177.8	260	25 4	MXS00016	—
7 1/4	184.2	270	25 4	MXS00017	—
7 1/2	190.5	170	15 2	MXS00018	—
7 1/2	190.5	225	20 3	MXS00019	—
7 1/2	190.5	280	25 4	MXS00020	MXS00021
7 3/4	196.9	290	25 4	MXS00022	MXS00023
8	203.2	240	20 3	MXS00024	MXS00025
8	203.2	300	25 4	MXS00026	MXS00027
8 1/4	209.6	310	25 4	MXS00028	MXS00029

Length in mm	Wattage	Watt Density		Part Number	
		W/in <sup>2</sup>	W/cm <sup>2</sup>	120V	240V
8 1/2	215.9	320	25 4	MXS00030	MXS00031
8 3/4	222.3	330	25 4	MXS00032	MXS00033
9	228.6	270	25 4	MXS00034	MXS00035
9	228.6	335	25 4	MXS00036	MXS00037
9 1/4	235.0	345	25 4	MXS00038	MXS00039
9 1/2	241.3	350	25 4	MXS00040	MXS00041
9 3/4	247.7	355	25 4	MXS00042	MXS00043
10	254.0	300	20 3	MXS00044	MXS00045
10	254.0	375	25 4	MXS00046	MXS00047
10 1/4	260.4	385	25 4	MXS00048	MXS00049
10 1/2	266.7	315	20 3	MXS00050	MXS00051
10 1/2	266.7	395	25 4	MXS00052	MXS00053
11	279.4	330	20 3	MXS00054	MXS00055
11	279.4	410	25 4	MXS00056	MXS00057
11 1/4	285.8	335	20 3	MXS00058	MXS00059
11 1/2	292.1	345	20 3	MXS00060	MXS00061
12	304.8	270	15 2	MXS00062	MXS00063
12	304.8	450	25 4	MXS00064	MXS00065
12	304.8	360	20 3	MXS00066	MXS00067
12 1/2	317.5	375	20 3	MXS00068	MXS00069
12 3/4	323.9	380	20 3	MXS00070	MXS00071
13	330.2	290	15 2	MXS00072	MXS00073
13	330.2	390	20 3	MXS00074	MXS00075
14	355.6	420	20 3	MXS00076	MXS00077



### Standard (Non-Stock) Sizes and Ratings

#### Width 2-1/2" (63.5 mm)

Length in mm	Wattage	Watt Density		Part Number		
		W/in <sup>2</sup>	W/cm <sup>2</sup>	120V	240V	
3½	88.9	175	20	3	MXS00078	—
3¾	95.3	230	25	4	MXS00079	—
4	101.6	250	25	4	MXS00080	—
4½	114.3	280	25	4	MXS00081	—
5	127.0	310	25	4	MXS00082	—
5½	139.7	340	25	4	MXS00083	—
6	152.4	375	25	4	MXS00084	—
6½	165.1	325	20	3	MXS00085	—
6¾	171.5	335	20	3	MXS00086	MXS00087
7	177.8	435	25	4	MXS00088	MXS00089
7¼	184.2	360	20	3	MXS00090	MXS00091
7½	190.5	465	25	4	MXS00092	MXS00093
7¾	200.0	295	15	2	MXS00094	MXS00095
8	203.2	400	20	3	MXS00096	MXS00097
8	203.2	500	25	4	MXS00098	MXS00099
8¼	209.6	410	20	3	MXS00100	MXS00101
8½	215.9	530	25	4	MXS00102	MXS00103
9	228.6	560	25	4	MXS00104	MXS00105
9½	241.3	590	25	4	MXS00106	MXS00107
10	254.0	500	20	3	MXS00108	MXS00109
10	254.0	625	25	4	MXS00110	MXS00111
10½	266.7	650	25	4	MXS00112	MXS00113
11	279.4	550	25	4	MXS00114	MXS00115
11½	292.1	575	20	3	MXS00116	MXS00117
11½	292.1	715	25	4	MXS00118	MXS00119
12	304.8	600	20	3	MXS00120	MXS00121
12	304.8	750	25	4	MXS00122	MXS00123
12½	317.5	625	25	4	MXS00124	MXS00125
13	330.2	650	25	4	MXS00126	MXS00127
13½	342.9	675	25	4	MXS00128	MXS00129
14	355.6	700	20	3	MXS00130	MXS00131
14	355.6	875	25	4	MXS00132	MXS00133

#### Width 3" (76.2 mm)

Length in mm	Wattage	Watt Density		Part Number		
		W/in <sup>2</sup>	W/cm <sup>2</sup>	120V	240V	
6	152.4	450	25	4	MXS00134	MXS00135
6½	165.1	485	25	4	MXS00136	MXS00137
7	177.8	525	25	4	MXS00138	MXS00139
7½	190.5	560	25	4	MXS00140	MXS00141
8	203.2	600	25	4	MXS00142	MXS00143
8½	215.9	635	25	4	MXS00144	MXS00145
9	228.6	675	25	4	MXS00146	MXS00147
9½	241.3	710	25	4	MXS00148	MXS00149
10	254.0	600	20	3	MXS00150	MXS00151
10½	266.7	630	20	3	MXS00152	MXS00153
11	279.4	660	20	3	MXS00154	MXS00155
11½	292.1	690	20	3	MXS00156	MXS00157
12	304.8	720	20	3	MXS00158	MXS00159
12½	317.5	750	20	3	MXS00160	MXS00161
13	330.2	780	20	3	MXS00162	MXS00163
13½	342.9	810	20	3	MXS00164	MXS00165

#### Width 4" (101.6 mm)

Length in mm	Wattage	Watt Density		Part Number		
		W/in <sup>2</sup>	W/cm <sup>2</sup>	120V	240V	
6	152.4	600	25	4	MXS00166	MXS00167
7	177.8	700	25	4	MXS00168	MXS00169
8	203.2	800	25	4	MXS00170	MXS00171
9	228.6	900	25	4	MXS00172	MXS00173
10	254.0	1000	25	4	MXS00174	MXS00175
11	279.4	880	20	3	MXS00176	MXS00177
12	304.8	960	20	3	MXS00178	MXS00179
12½	317.5	1000	20	3	MXS00180	MXS00181
13	330.2	1040	20	3	MXS00182	MXS00183
13½	342.9	1080	20	3	MXS00184	MXS00185

### Ordering Information

#### Catalog Heaters

Select a Maxistrip Heater from the Standard Sizes and Ratings lists above. Note that Part Numbers shown are for heaters with type "S" termination. Specify Part Number and Quantity. Lead time is 3 weeks.

#### Custom Engineered/Manufactured Heaters

An electric heater can be very application specific; for sizes and ratings not listed, TEMPCO will design and manufacture a Maxistrip Heater to meet your requirements. **Standard lead time is 3 weeks.**

**Please Specify** the following:

- Width
- Length
- Wattage
- Voltage
- Termination Types
- Lead Length
- Cable/Braid Length
- Optional Features

**⚠ WARNING:** Cancer and Reproductive Harm - [www.P65Warnings.ca.gov](http://www.P65Warnings.ca.gov).