

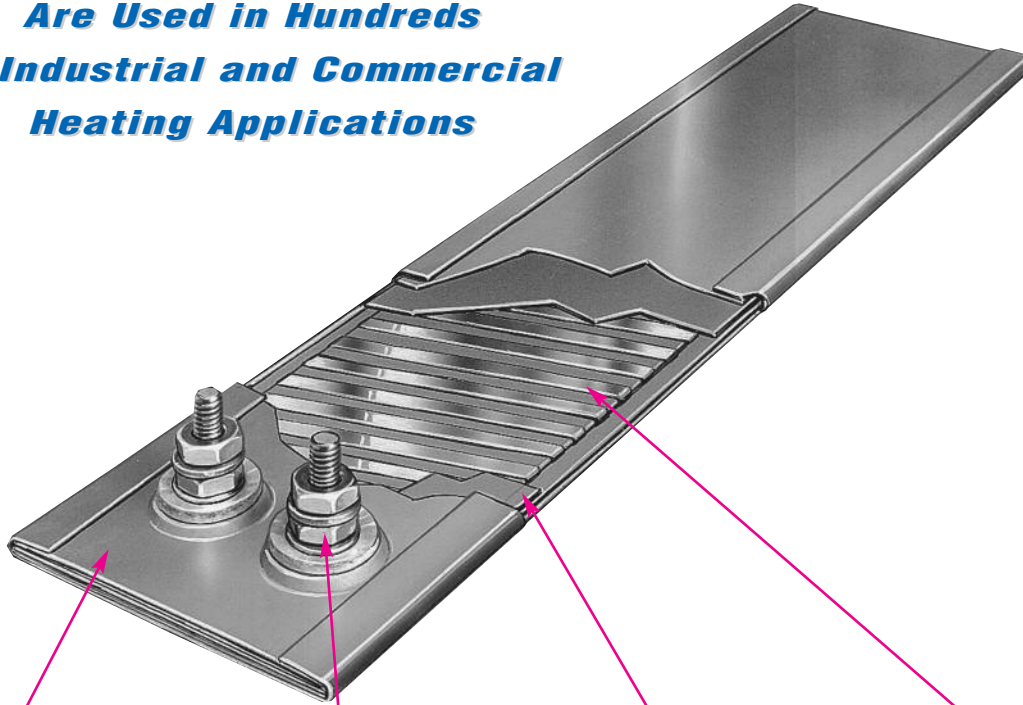

MICA INSULATED

**Mica Insulated Strip Heaters
Are Used in Hundreds
of Industrial and Commercial
Heating Applications**

**AN ECONOMICAL,
PRACTICAL AND
RELIABLE
HEAT SOURCE
CAPABLE OF
PROVIDING
UNIFORM HEAT
TRANSFER TO
FLAT SURFACES**



A Specially treated rust-resistant steel sheath casing provides the best combination of physical strength, high emissivity and good thermal conductivity for sheath temperatures up to 900°F (480°C). For corrosive atmospheres and/or sheath temperatures up to 1200°F (650°C), stainless steel sheath is available.

B For maximum connecting surface, the specially designed stainless steel screw terminals are securely fastened to a connecting jumper, assuring positive contact with the windings, providing maximum current carrying capacity. For other terminal or lead arrangements, see pages 8-22 and 8-23.

C Specially selected mica grade and thickness is used to insulate the windings, providing excellent thermal conductivity and dielectric strength.

D A specific nickel-chrome resistance ribbon wire size is properly engineered to achieve the best combination of wire gauge and spacing between turns, thereby providing the lowest winding temperature possible. The ribbon wire is wound on a specially selected Mica Strip, providing even heat distribution for maximum heater life.

Typical Applications

- Food Warming Equipment
- Packaging Equipment
- Blow Molding Equipment
- Testing Equipment
- Vulcanizing Presses
- Vending Machines
- Hot Plates
- Ovens
- Molds
- Kettles
- Incubators

Agency Approvals



Mica Strip heaters are UL recognized and CSA certified in many design variations. Tempco's UL file number is E65652 and CSA file number is 043099.

If you require UL, CSA, or other NRTL agency approvals, please specify when ordering.





Specifications & Tolerances

Standard Specifications and Tolerances of Mica Insulated Strip Heaters
If tighter tolerances are required consult Tempco. A heater's physical size combined with electrical ratings will determine the actual minimums and maximums.

PERFORMANCE RATINGS

Maximum Sheath Temperature

Rust resistant steel: 900°F (480°C)
Stainless Steel: 1200°F (650°C)

Nominal Watt Density: 5-45 W/in² (0.8-7.0 W/cm²)

Maximum Watt Density: Depends on operating temperature and heater size. 38 W/in² (5.9 W/cm²) Maximum when UL & CSA approval is required.

ELECTRICAL SPECIFICATIONS

Maximum Voltage: 480 Volts

Maximum Amperage: lead wire termination: 10 amp
screw terminations: 8-32UNF—20 amp; 10-32UNF—25 Amps

Resistance Tolerance: +10%, -5%

Wattage Tolerance: +5%, -10%

Formula for Calculating Watt Density

$$\text{Watt Density} = \frac{\text{Heater Wattage}}{(\text{Heater Width} - 3/8) \times (\text{Heater Length} - \text{Cold Area}^*)}$$

* Cold Area consists of Holes or Cutouts.

MATERIAL SPECIFICATIONS & PHYSICAL SIZES

Standard Sheath Material: Rust resistant steel

Optional: Stainless Steel or Aluminum

Nominal Thickness: 3/16" (4.76 mm)

Minimum Width: 5/8" (15.88 mm)
May vary depending on Termination

Width Tolerance: ±1/32" (0.79 mm)

Maximum Length: 72" (1829 mm)

Length Tolerance: Up to 24" (610 mm) ±1/16" (1.59 mm)
Over 24" (610 mm) ±1/8" (3.18 mm)

Screw Terminals

1" (25.4 mm) wide strips: 8-32 threads

Over 1" (25.4 mm) wide strips: 10-32 threads

Minimum Termination Distance from Edge of Heater

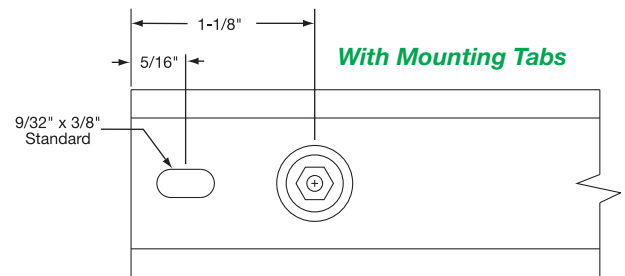
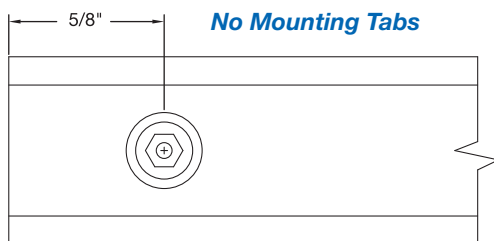

Installation

- Tempco Mica Insulated Strip Heaters are available with mounting slots at each end for surface mounting applications or without mounting slots for insertion into milled slots.
- For surface mounting installations, Mica Strip heaters must be clamped securely along their entire length to a smooth metal surface by using metal clamps 3" to 5" apart.
- Holes along the body of the strip heater for mounting purposes are not recommended and should only be used when there is no other means of clamping the strip heater down. These holes take up valuable winding space, increasing watt density, resulting in poor heater life.

Instructions

- When supported by mounting slots, the terminal end should be secured firmly. Opposite end should be slightly loosened to allow for linear expansion.
- The surface being heated must be clean and smooth for efficient heat transfer. Small air gaps caused by imperfections can cause hot spots, resulting in heater failure.
- Contaminants such as oil, plastics, and dirt should not be allowed to collect on heaters, as they will find their way into the heater windings, eventually carbonizing and causing electrical shorts.

Strip Heaters



Terminations

Screw Terminal Terminations

Type T1

Screw terminals at opposite ends.
Minimum Width required is 7/8".



Type T2

Screw terminals tandem at one end.
Minimum Width required is 7/8".

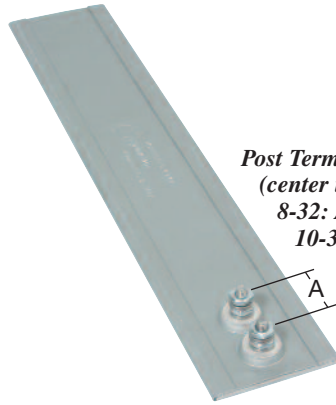

*Post Terminals
(center to center)*
8-32: A=3/4"
10-32: A=7/8"

Type T3

Screw terminals parallel at one end.
Minimum Width required is 2".

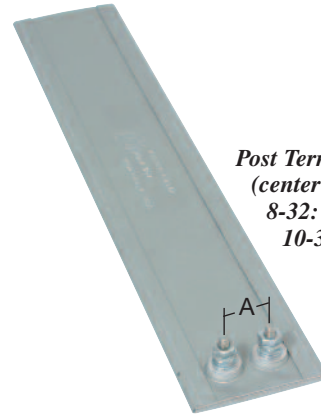

*Post Terminals
(center to center)*
8-32: A=3/4"
10-32: A=7/8"

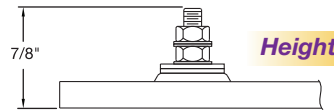

Note: Typical Termination locations shown (pages 8-22, 23). Specify terminal locations when ordering.

Terminal Protection

Type B__

Low-profile 10-32 button terminals with binding head screws. Same location and minimum width requirements as types T1, T2 and T3. 6-32 threads available.

- Type B1** Terminals at opposite ends (see T1)
- Type B2** Terminals same end (see T2)
- Type B3** Terminals same end (shown)

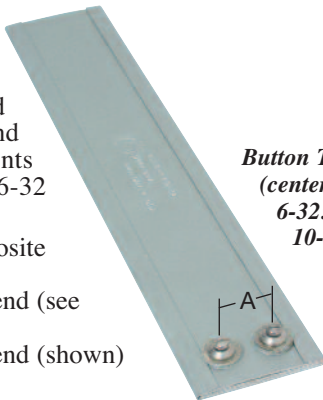

*Button Terminals
(center to center)*
6-32: A= 1-1/8"
10-32: A= 7/8"

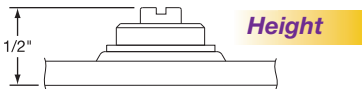

Type C__

Terminal box has one 1/2" trade size knockout (actual diameter 7/8") for ease of wiring. It provides excellent protection against exposed terminals. Boxes can be prewired with armor cable or wire braid.

- Type CA** Box only
- Type CB** Box with galvanized cable
- Type CC** Box with Stainless Steel cable
- Type CD** Box with wire braid

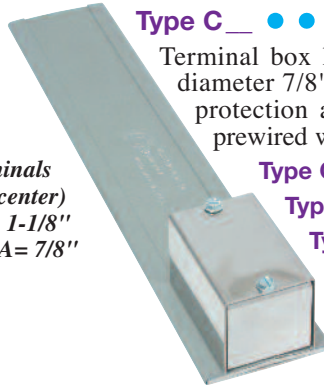

Igloo™

Igloo ceramic terminal covers consist of two ceramic parts. With a tight-fitting cap and a solid base, an Igloo cover will fully insulate any standard 8-32 or 10-32 terminal lug used for electrical wiring hookup. Igloo covers can be assembled onto any standard mica strips with 10-32 screw terminals. Igloo covers are available in 3 different styles: single port, double port in-line and double port 90°. See page 15-13 for specific part numbers. Heater with double port in-line Igloo cover shown here.



Type P1__

High-Temperature quick-disconnect plug. Available on 7/8" widths (depending on termination configuration) and wider with cup and plug assembly or just cup. Type P1Q shown with 90° plug and galvanized armor cable. Other options available. Consult Tempco.





Lead Wire Terminations

Type W1

Wire braid leads offer sharp bending not possible with armor cable. 10" of wire braid over 12" leads is standard. If longer braid or leads are required, specify.

Minimum Width required is 7/8".



Type W2

Flexible stainless steel braided lead wires exiting at same end. 10" stainless steel braid over 12" leads is standard. If longer braid or leads are required, specify.

Minimum Width required is 1-1/8".

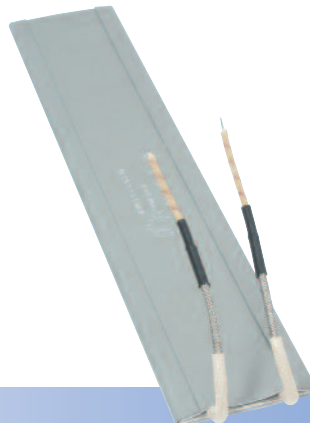

Type W3

Flexible stainless steel braided lead wires exiting at opposite ends. 10" stainless steel braid over 12" leads is standard. If longer braid or leads are required, specify.

Minimum Width required is 3/4".



Type L1

Flexible lead wire exiting from the top through a brass eyelet. 10" long leads standard; if longer leads are required, specify.

Minimum Width required is 7/8".



Type L2

Flexible lead wire exiting same end. 10" long leads standard; if longer leads are required, specify.

Minimum Width required is 1-1/8".

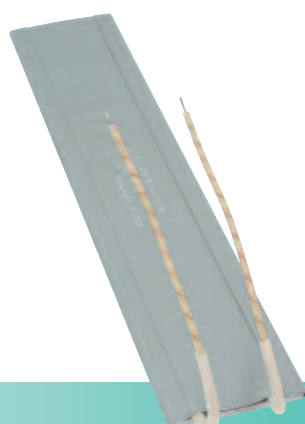

Type L3

Flexible lead wire exiting at opposite ends. 10" long leads standard; if longer leads are required, specify.

Minimum Width required is 3/4".



Abrasion Resistant Terminations

Type R1

Armor cable provides far superior protection to lead wires where abrasion is a constant problem. Available with two- or three-prong plugs. 10" of armor cable over 12" leads is standard. If longer cable, leads or plugs are required, specify.

Minimum Width required is 1".

- Type R1A** Galvanized cable, crimped
- Type R1B** Stainless Steel cable, crimped
- Type R1C** Galvanized cable, tack welded
- Type R1D** Stainless Steel cable, tack welded
- Type R1E** Galvanized cable, full silver brazing
- Type R1F** Stainless Steel, full silver brazing

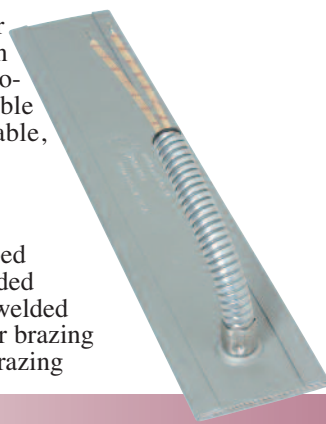

Type R2

Right-angle armor cable can be positioned in any direction. 10" of armor cable over 12" leads is standard. If longer leads are required, specify.

Minimum Width required is 1-1/4".

- Type R2A** Galvanized cable, crimped
- Type R2B** Stainless Steel cable, crimped
- Type R2C** Plain leads, no cable

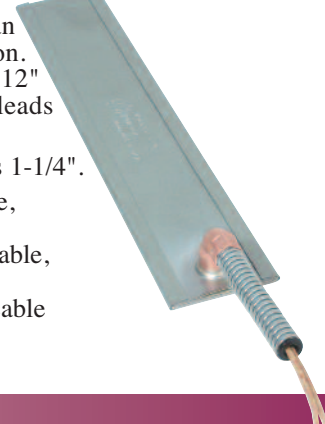

Strip Heaters



Standard Sizes and Ratings

Width		Length		Wattage	Watt Density		Termination	Part Number	
in	mm	in	mm		W/in ²	W/cm ²		120V	240V
1	25.4	6	152.4	100	32	5	L2	MSH00001	MSH00002
1	25.4	22½	571.5	525	39	6	W1	—	MSH00003
1¼	31.8	40	1016.0	750	31	5	R2	—	MSH00004
1½	38.1	5½	139.7	225	44	7	L1	—	MSH00005
1½	38.1	5½	139.7	225	44	7	L2	—	MSH00006
1½	38.1	5½	139.7	125	25	4	T2	MSH00007	—
1½	38.1	6	152.4	300	53	8	L2	MSH00008	—
1½	38.1	6	152.4	250	44	7	W1	—	MSH00009
1½	38.1	8	203.2	355	45	7	L2	—	MSH00010
1½	38.1	8	203.2	400	51	8	L2	MSH00011	MSH00012
1½	38.1	8	203.2	400	51	8	T2	MSH00013	—
1½	38.1	9½	241.3	200	21	3	L2	—	MSH00014
1½	38.1	10	254.0	450	44	7	L2	—	MSH00015
1½	38.1	10½	266.7	250	23	4	T2	MSH00016	—
1½	38.1	11	279.4	500	44	7	L1	—	MSH00017
1½	38.1	11	279.4	600	53	8	W1	—	MSH00018
1½	38.1	12	304.8	400	32	5	L2	MSH00019	—
1½	38.1	14	355.6	500	34	5	T2	MSH00020	—
1½	38.1	16	406.4	600	36	6	L2	—	MSH00021
1½	38.1	17	431.8	500	28	4	L1	—	MSH00022
1½	38.1	18	457.2	500	26	4	L2	MSH00023	—
1½	38.1	22½	571.5	775	32	5	W1	—	MSH00024
1½	38.1	24	609.6	1000	39	6	L2	—	MSH00025
1½	38.1	30	762.0	1000	31	5	L2	—	MSH00026
1½	38.1	36	914.4	1000	25	4	L2	—	MSH00027
1½	38.1	36	914.4	1000	25	4	T2	MSH00028	—
2	50.8	3	76.2	100	31	5	T2	—	MSH00029
2	50.8	4	101.6	20	4	1	T2	MSH00030	—
2	50.8	4	101.6	30	6	1	T2	MSH00031	—
2	50.8	4	101.6	40	8	1	T2	MSH00032	—
2	50.8	4	101.6	50	10	2	T2	MSH00033	—
2	50.8	4	101.6	100	21	3	T3	—	MSH00034
2	50.8	4	101.6	100	21	3	W1	—	MSH00035
2	50.8	4	101.6	150	31	5	W1	—	MSH00036
2	50.8	4	101.6	200	41	6	W1	—	MSH00037
2	50.8	8	203.2	275	24	4	L1	—	MSH00038
2	50.8	27½	698.5	1200	28	4	L2	—	MSH00039
2	50.8	43	1092.2	1400	21	3	T2	—	MSH00040
2¼	61.9	5½	139.7	350	38	6	T3	—	MSH00041
2½	63.5	4	101.6	150	24	4	T1	—	MSH00042
2½	63.5	6	152.4	350	33	5	R1	—	MSH00043
2½	63.5	8½	215.9	350	22	3	T3	—	MSH00044
2½	63.5	10	254.0	350	18	3	L2	MSH00045	MSH00046
2½	63.5	14	355.6	625	23	4	L2	MSH00047	—
2¾	73.0	6	152.4	300	24	4	T3	MSH00048	—
2¾	73.0	6	152.4	300	24	4	T3	—	MSH00049
3	76.2	7	177.8	200	13	2	L1	MSH00050	—
3	76.2	7	177.8	500	32	5	L1	MSH00051	—
3	76.2	12	304.8	180	6	1	T1	MSH00052	—
3	76.2	12½	317.5	300	10	2	T3	—	MSH00053
3	76.2	15	381.0	500	14	2	L1	MSH00054	—
3	76.2	26	660.4	600	9	1	R1	—	MSH00055
3½	88.9	4	101.6	100	11	2	W2	—	MSH00056
3½	88.9	4½	114.3	500	46	7	W1	—	MSH00057
3½	88.9	7½	190.5	500	25	4	T3	MSH00058	—
3½	88.9	10	254.0	900	32	5	W2	—	MSH00059
3½	88.9	14	355.6	450	11	2	B3	MSH00060	—
4	101.6	4	101.6	275	25	4	R2	—	MSH00061
4	101.6	8	203.2	425	17	3	T3	—	MSH00062
4	101.6	11	279.4	750	21	3	T3	—	MSH00063
4	101.6	20	508.0	1750	25	4	R1	—	MSH00064
4¾	111.1	7¼	179.4	800	33	5	W2	—	MSH00065
4¾	120.7	5½	139.7	700	36	6	T2	—	MSH00066
4¾	120.7	11¼	285.8	200	4	1	T3	—	MSH00067
4¾	123.8	11¼	290.5	1200	26	4	T3	—	MSH00068
5⅞	149.2	11	279.4	425	8	1	R1	MSH00069	—
6	152.4	12	304.8	1200	19	3	T3	—	MSH00070
6	152.4	15	381.0	575	7	1	T3	—	MSH00071
7	177.8	11½	292.1	625	9	1	R1	MSH00072	—
8	203.2	9¼	235.0	450	7	1	T3	—	MSH00073
8	203.2	10	254.0	450	7	1	T3	—	MSH00074
10	254.0	18	457.2	300	2	0	B3	MSH00075	—

Standard (Non-Stock) Sizes and Ratings — Heaters Without Mounting Slots

Termination **Types L1** and **L2** have 10" leads.

R1 and **R2** have 10" galvanized armor cable over 12" leads.

W1 and **W2** have 10" stainless steel braid over 12" leads.



Stock Sizes and Ratings — Heaters With Mounting Slots

Termination Type T2: Post Terminals tandem at one end.

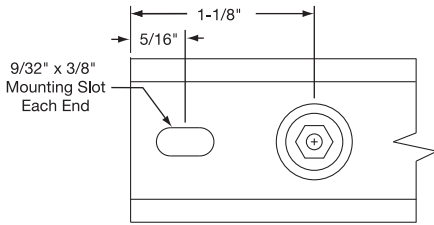

Width		Length		Wattage	Watt Density		Part Number	
in	mm	in	mm		W/in ²	W/cm ²	120V	240V
1½	38.1	4	101.6	75	30	5	MSH02258	MSH02259
3	76.2	4	101.6	120	19	3	MSH02273	MSH02272
1½	38.1	6	152.4	100	23	4	MSH02260	MSH02261
3	76.2	6	152.4	180	17	3	MSH02274	MSH02275
1½	38.1	8	203.2	150	22	3	MSH02262	MSH02263
3	76.2	8	203.2	240	16	2	MSH02276	MSH02277
1½	38.1	10	254.0	200	23	4	MSH02264	MSH02265
3	76.2	10	254.0	300	15	2	MSH02278	MSH02279
1½	38.1	12	304.8	300	28	4	MSH02266	MSH02267
3	76.2	12	304.8	360	15	2	MSH02280	MSH02281
1½	38.1	16	406.4	400	26	4	MSH02268	MSH02269
3	76.2	16	406.4	450	14	2	MSH02282	MSH02283
1½	38.1	24	609.6	600	26	4	MSH02270	MSH02271
3	76.2	24	609.6	600	14	2	MSH02284	MSH02285

Ordering Information

Catalog Heaters

Select a Mica Strip Heater from the Standard Sizes and Ratings List on pages 8-24 and 8-25. Specify Part Number and Quantity. Lead time is 2 weeks.

Custom Engineered/Manufactured Heaters

An electric heater can be very application specific; for sizes and ratings not listed, **TEMPCO** will design and manufacture a Mica Insulated Heater to meet your requirements. **Standard lead time is 2 weeks.**

Please Specify the following:

- Width
- Length
- Wattage
- Voltage
- Termination Type
- Lead Length
- Cable/Braid Length
- Optional Features

⚠ WARNING: Cancer and Reproductive Harm - www.P65Warnings.ca.gov.

Additional Mica Strip Heater Optional Features

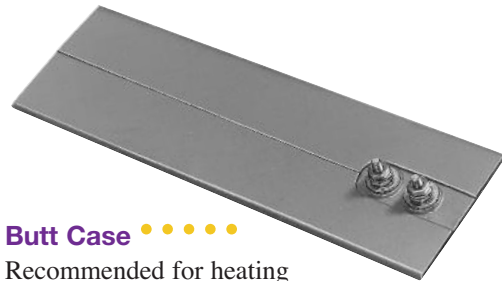

Butt Case

Recommended for heating applications where strip heater will be placed in a milled slot between two steel plates.

Pressure Plate

Strip Heaters can be made with built-in pressure plate to add rigidity and minimize warping of the heater. Standard plate thickness is 1/8". Specify plate thickness and choice of mounting method 1 or mounting method 2.

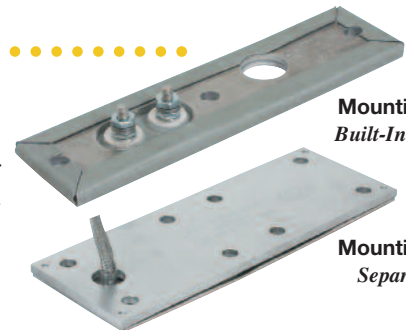

Mounting Method 1
Built-In Pressure Plate

Mounting Method 2
Separate Pressure Plate



Four Sides Closed

Mica Strip Heaters can be closed on all four sides to reduce contamination from getting inside the heater. Recommended on all strip heaters over 2-1/2" in width.

Cross-Section-Formed

Strip Heaters can be formed on their cross section for pipe heating applications. 2" minimum width required. Specify diameter of pipe on which heaters are to be mounted.



CONTINUED

Strip Heaters



Optional Features

Additional Mica Strip Heater Optional Features

Continued from previous page...

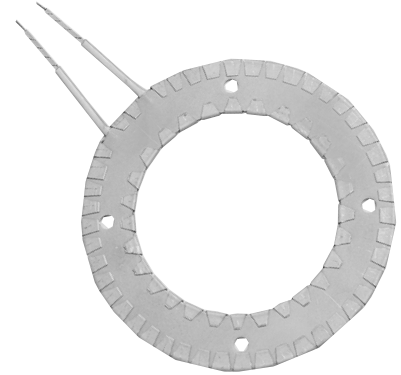
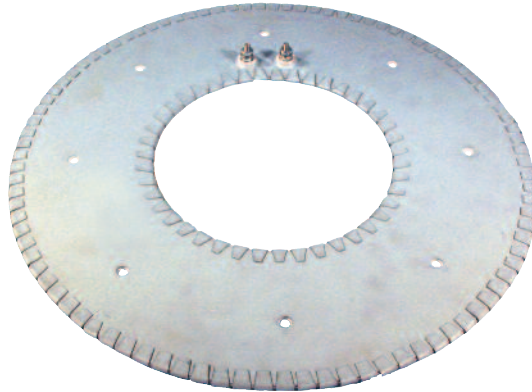

Disc Heater

When ordering Disc Heaters, specify outside diameter, electrical ratings, and termination type. If mounting holes are required, specify location and hole size.

Ring Heaters

When ordering Ring Heaters, specify inside and outside diameters, electrical ratings, and termination type. If mounting holes are required, specify location and hole size.

Custom Engineered/Manufactured

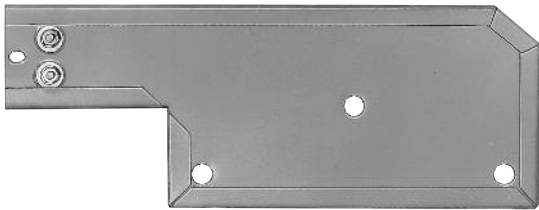

Irregular Shape

Mica Strip Heaters can be made into any practical shape and electrical rating. We welcome your inquiries.

Sinuated (Serpentine) Element Design

Sinuated (Serpentine) wound coil design is used for low temperature and low watt density applications within the 3-10 amp range.

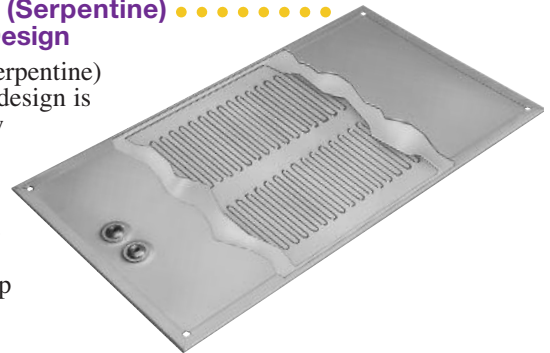

Non-Metal Sheath Custom Mica Heaters



Open Element

This economical heater design without the metal case is commonly used in laminating machines. The heater assembly can be suspended or sandwiched between non-metallic machine parts, eliminating the need for additional and expensive metal cases.



Distributed Wattage

A mica strip heater can be designed with varying heat profile along the length for uneven heat distribution.

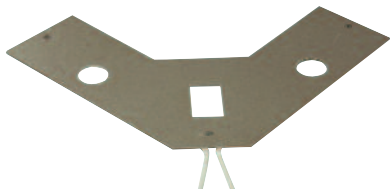

Irregular Shape

Non-Metal Sheath Strip Heaters can be made into any practical shape and electrical rating. We welcome your inquiries.

EXPERIENCE THE TEMPCO ADVANTAGE

Strip Heaters shown on this page are a small representation of the many Custom Engineered and Manufactured designs we have produced.

If you have a special application and need free technical assistance, consult our team of professionals with your requirements.

We Welcome Your Inquiries