

Main applications

- Packaging Machinery
- Thermoforming
- Plastic extrusion lines
- Industrial ovens and furnaces
- Control application with high switching speed



Main features

- Alternating current solid state relay
- Zero crossing switching
- 15, 25, 50, 75 e 90 Arms nominal current
- Non-repetitive voltage: up to 1600Vp
- Nominal Voltage: up to 600 Vac
- Control voltage : 3...32Vcc and 20...260Vac/Vcc with connector
- Isolation ((input-output) 4000Vrms
- Green LED drive active signal

PROFILE

Zero crossing relay with antiparallel thyristor output is the most used solid state relay in industrial applications.

In fact, it can be used for resistive, inductive and capacity loads.

"Zero crossing" relay is energised when voltage meets the zero point and disenergised when current meets the zero point, depending on the signal control on the input circuit.

This relay has been designed to stand high-value transitory applications .

When the relay has to stand high currents for a long period, it is necessary to grant a proper dissipation and an adequate electrical connection between relay terminals and the load.

Fuses, thermostats and fans are available as fittings.

Use the relay with an oportune heatsink (see section accessories).

TECHNICAL DATA

General features

Rated frequency: 45...65Hz

Activation time:

GQ...-D- $\leq 1/2$ cycle GQ...-A- ≤ 1 cycle

Deactivation time:

GQ...-D- $\leq 1/2$ cycle GQ...-A- ≤ 1 cycle

Power factor: $\geq 0,5$

Protection level: IP20

• $U_{imp} = 4,8KV$

• $U_i = 660V$

• Overload current profile = 10

• Conditional short circuit current = 5KA with type 1 coordination and respective fuse protections.

GQ15/25 fuse type aM6A

GQ50 fuse type aM16A

GQ75/90 fuse type aM20A

GQ...- 24-

Nominal voltage: 24...230 Vac

(max range 20...253Vac)

Non-repetitive voltage: ≥ 600 Vp

Zero switching voltage: $\leq 20V$

GQ...- 48-

Nominal voltage: 48...480 Vac

(max range 40...528Vac)

Non-repetitive voltage: ≥ 1200 Vp

Zero switching voltage: ≤ 40 V

GQ...- 60-

Nominal voltage: 48...600 Vac

(max range 40...660Vac)

Non-repetitive voltage: ≥ 1200 Vp

Zero switching voltage: $\leq 40V$

Control input A1 - A2

GQ...-D-

Control voltage: 3...32Vcc

Turn ON voltage: $\geq 2,7Vc.c$

Turn OFF voltage: $\leq 1Vcc$

Reverse voltage: $< 36Vcc$

Consumption: $\leq 13mA@32V$

UL Overvoltage category II or III

GQ...-A-

Control voltage: 20...260Vac/Vcc

Turn ON voltage: $\geq 15Vac/Vcc$

Turn OFF voltage: $\leq 6Vac/Vcc$

Consumption: $\leq 8mAac/cc@260Vac/Vcc$

Series connection of control inputs: max.

no. GQ...-A in series = $V_{control} - 10\% / 20$

UL Overvoltage category II

Output L1 - T1

UL Overvoltage category III

GQ - 15 -

Nominal current: AC51: 15Arms;

AC53A (*): 3Arms

Min load current: 0,1Arms

Repetitive overcurrent $t=1$ s: $\leq 35Arms$

Non-repetitive overcurrent $t=20ms:200Ap$

Current drop at nominal voltage and frequencies: $\leq 8mArms$

I^2t for fusing $t=1-10ms: \leq 200A^2s$

Critical $dI/dt: \geq 100A/\mu s$

Voltage drop at nominal current: $\leq 1,45Vrms$

Critical dV/dt off-state: $\geq 1000V/\mu s$

$I_{th} = 15A$

GQ - 25 -

Nominal current :

AC51: 25Arms; AC53A (*): 5Arms

Min load current: 0,3Arms

Repetitive overcurrent $t=1$ s: ≤ 60 Arms

Non-repetitive overcurrent $t=20$ ms: 300Ap

Current drop at nominal voltage and frequencies: ≤ 8 mArms

I^2t for fusing $t=1-10$ ms: $\leq 450A^2s$

Critical dI/dt : $\geq 100A/\mu s$

Voltage drop at nominal current: $\leq 1,45Vrms$

Critical dV/dt off-state: $\geq 1000V/\mu s$

$I_{th} = 25A$

GQ - 50 -

Nominal current :

AC51: 50Arms; AC53A (*): 15Arms

Min load current: 0,3Arms

Repetitive overcurrent $t=1$ s: ≤ 125 Arms

Non-repetitive overcurrent $t=20$ ms: 600Ap

Current drop at nominal voltage and frequencies: ≤ 8 mArms

I^2t for fusing $t=1-10$ ms: $\leq 1800A^2s$

Critical dI/dt : $\geq 100A/\mu s$

Voltage drop at nominal current: $\leq 1,35Vrms$

Critical dV/dt off-state: $\geq 1000V/\mu s$

$I_{th} = 50A$

GQ - 75 -

Nominal current : AC51: 75Arms;

AC53A (*): 18Arms

Min load current: 0,5Arms

Repetitive overcurrent $t=1$ s: ≤ 150 Arms

Non-repetitive overcurrent $t=20$ ms: 1600Ap

Current drop at nominal voltage and frequencies: ≤ 10 mArms

I^2t for fusing $t=1-10$ ms: $\leq 12800A^2s$

Critical dI/dt : $\geq 100A/\mu s$

Voltage drop at nominal current: $\leq 1,3Vrms$

Critical dV/dt off-state: $\geq 1000V/\mu s$

$I_{th} = 75A$

GQ - 90 -

Nominal current AC51: 90Arms;

AC53A (*): 20Arms

Min load current: 0,5Arms

Repetitive overcurrent $t=1$ s: ≤ 150 Arms

Non-repetitive overcurrent $t=20$ ms: 1600 Ap

Current drop at nominal voltage and frequencies: ≤ 10 mArms

I^2t for fusing $t=1-10$ ms: $\leq 12800A^2s$

Critical dI/dt : $\geq 100A/\mu s$

Voltage drop at nominal current: $\leq 1,3Vrms$

Critical dV/dt off-state: $\geq 1000V/\mu s$

$I_{th} = 90A$

(*) Only versions: GQ-XX-24-X-1

GQ-XX-48-X-1

Insulation

Nominal insulation voltage Input/output:

≥ 4000 Vac

Nominal insulation voltage Output/case:

≥ 2500 Vac

Insulation resistance Input/output: $\geq 10^{10}\Omega$

Insulation resistance Output/case: $\geq 10^{10}\Omega$

Insulation capacity Input/Output: ≤ 8 pF

Insulation capacity Output/case: ≤ 100 pF

Ambient conditions

- Ambient temperature: $-25...+80^\circ C$
- Storage Temperature: $-55...+100^\circ C$
- Maximum relative humidity: 90% a $40^\circ C$
- Maximum installation height: 2000 slm
- Pollution level: 2

UL Enviromental Ratings

- Open Type Device
- Surrounding Air Temperature $40^\circ C$
- Pollution degree 2

Thermal features

GQ - XX -

Junction Temperature: $\leq 125^\circ C$

GQ - 15 - / GQ - 25 -

R_{th} junction/case: $\leq 1,25$ K/W

GQ - 50 -

R_{th} junction/case: $\leq 0,65$ K/W

GQ - 75 -

R_{th} junction/case: $\leq 0,4$ K/W

GQ - 90 -

R_{th} junction/case: $\leq 0,3$ K/W

Solid State Relay Dissipated Power Calculation

Single phase state relay

P_d GQ .. 15/25 = 1,45 . I_{rms} [W]

P_d GQ .. 50 = 1,35 . I_{rms} [W]

P_d GQ .. 75/90 = 1,3 . I_{rms} [W]

I_{RMS} = single-phase load current

Heatsink Thermal Resistance Calculation

$R_{th} = (90^\circ C - T_{amb. max}) / P_d$

where P_d = dissipated power

Max. amb. T = max air temperature inside the electrical cabinet.

Use a heatsink with thermal resistance inferior to the calculated one (R_{th}).

Installation notes

The device must be protected by a high speed fuse (accessory).

Applications with power solid state relays must also have a switch to isolate the power line.

Protect the solid state relay against overheating by using a heatsink (accessory).

The heatsink must be sized according to room temperature and load current (see technical data).

Heatsink installation procedure:

spread 1 gram of thermoconductive silicone paste (we recommend DOW CORNING 340) on the dissipative metal surfaces of the module.

The surfaces must be clean and the thermoconductive paste must not contain any impurities.

Alternately tighten the two fastening screws until reaching a torque of 0.4...0.6 Nm.

DIMENSIONS

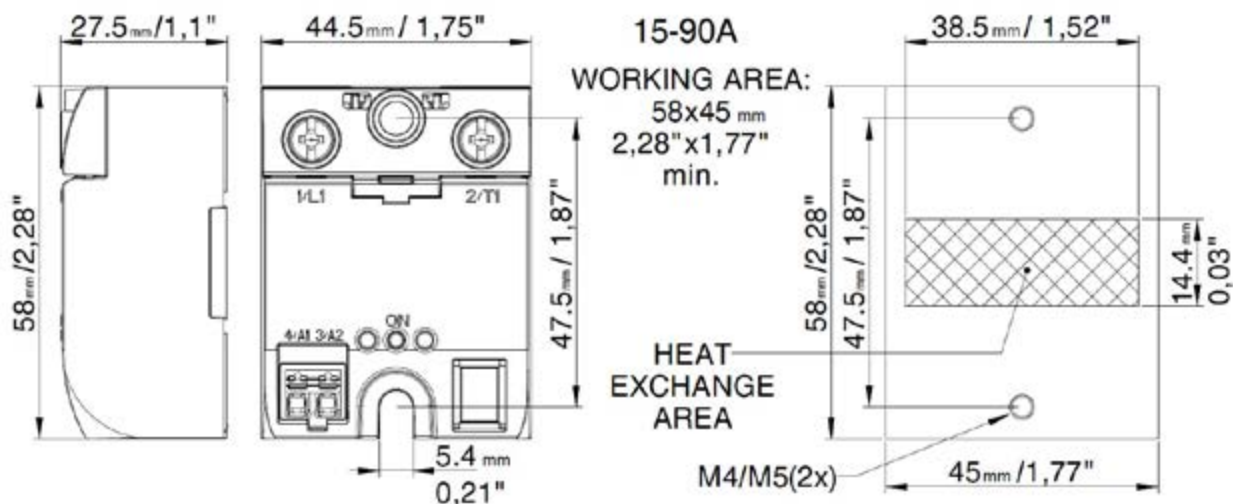

Wait 5 minutes for any excess paste to run off.
Alternately tighten the two fastening screws until reaching a torque of 1.2...1.4 Nm.

The heatsink must be grounded.

be examined and replaced if damaged. If burnout of the device occurs, the complete device must be replaced or equivalent.

Attention

The contact surface of the heatsink module may have a maximum planarity error of 0.1 mm and maximum roughness of 0.02 mm. The fastening holes on the heatsink must be threaded and countersunk.

Attention

The opening of the branch-circuit protective device may be an indication that a fault has been interrupted. To reduce the risk of fire or electric shocks, current-carrying parts and other components of the device should

ELECTRICAL CONNECTIONS



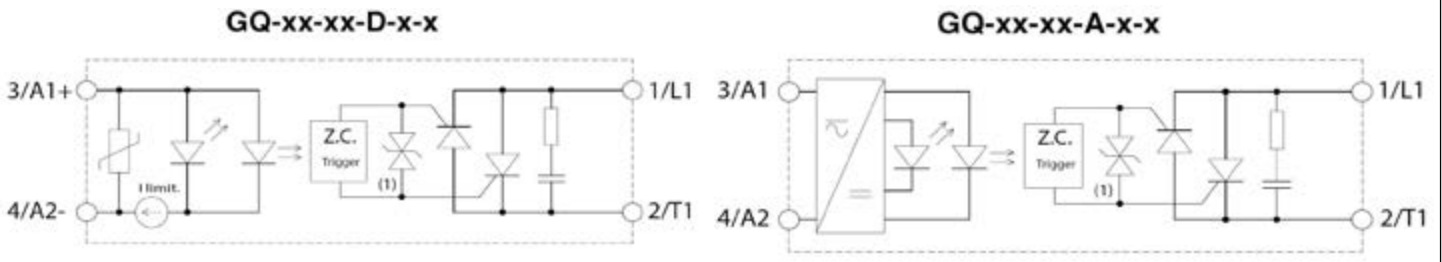

Functional Diagram

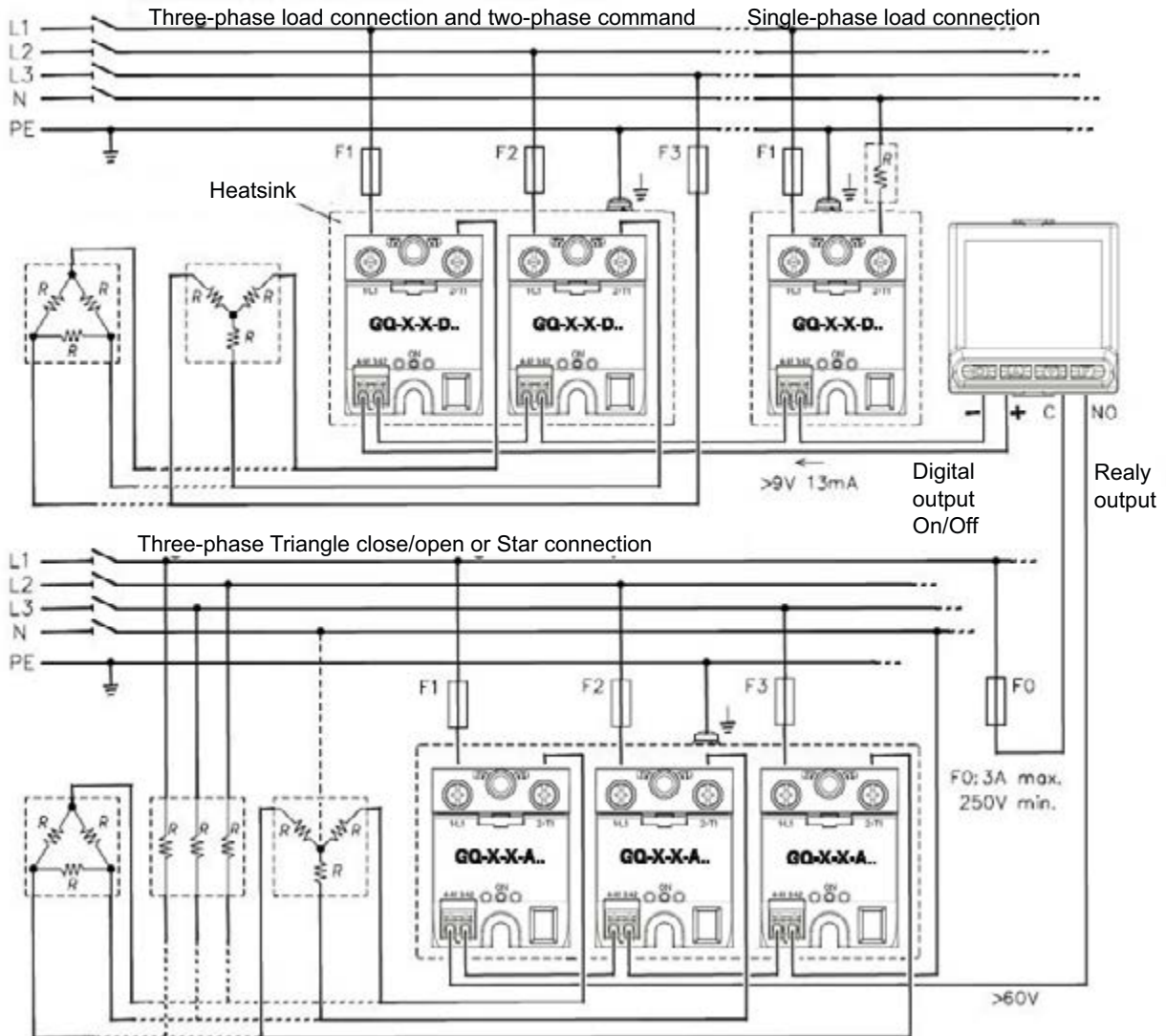

Only GQ-xx-xx-1-x



TERMINALS AND LEADS: SPECIFICATIONS

Description	Power terminals		2 poles command terminals 3-A1 / 4-A2			
	1-L1	2-T2				
Terminal type	screw (M4) contact area (LxP) 13x11mm		with self-locking spring MORS1 extractable	with spring double connection MORS2 extractable	with screw M3 MORS3 extractable	PUSH-IN MORS4 not extractable
Stripped wire	1x2.5...6mm ² 2x1.5...2.5mm ² 2x2.5...6mm ² Stripped 11mm		1x0.2...2.5mm ² 2x0.5...0.75mm ² (#) Stripped 10mm	2x(1x0.2...2.5mm ²) 2x(2x0.2...0.75mm ²)(#) Stripped 10mm	1x0.25...2.5mm ² 2x0.25...1mm ² (#) Stripped 7mm	1x0.5...1.5mm ² Stripped 6mm
Prod cable	1x1.5...6mm ² 2x1.5...2.5mm ² 2x2.5...6mm ²		1x0.2...1.5mm ² 2x0.2...0.75mm ² (#)	2x(1x0.25...2.5mm ²) 2x(2x0.25...0.75mm ²)(#)	1x0.25...2.5mm ² 2x0.25...1mm ² (#)	---
Prod cable with collar	1x1.5...10mm ² 2x1.5...2.5mm ² 2x2.5...6mm ²		1x0.2...1.5mm ²	1x0.25...1.5mm ²	1x0.25...2.5mm ² 2x0.25...1.5mm ² (#)	---
Fork or eyelet cable	1x2.5...25mm ²		---	---	---	---
Locking torque / screwdriver type	slot 1x5...6mm cross ø 5...6mm 2 - 2,4 Nm (18 - 21,3 lb.in)		with slot 0,6x3,5mm for contact opening thrust	with slot 0,6x3,5mm for contact opening thrust (with flexible strip- ped cable)	with slot 0,6x3,5mm with cross ø 3...3,8mm 0,5 - 0,6 Nm (4,4 - 5,3 lb.in)	with slot 0.6x3.5mm
(#) When inserting two leads in the same terminal they must have the same cross-section Note: The minimum and maximum sections shown refer to unipolar copper wires isolated in PVC.						

SCCR FUSES

SCCR CO-ORDINATION FUSES TABLE				
Model	Short circuit current [Arms]	Max fuse size [A]	Bussmann Model Number	Max Voltage [VAC]
GQ 15	100.000	25	DFJ-25	600
GQ 25	100.000	25	DFJ-25	600
GQ 50	100.000	50	DFJ-50	600
GQ 90	100.000	100	DFJ-100	600

“The fuses on the above table are representative of all the Bussmann DFJ fuses with lower current ratings”

“The devices protected with the fuses reported above, still be functional after the short circuit”

Short circuit protection: The product variants listed in the table “SCCR COORDINATION FUSES” are “Suitable For Use On A Circuit Capable Of Delivering Not

More Than 100,000 A rms Symmetrical Amperes, 600 Volts Maximum when Protected by fuses.

Attention: the opening of the branch-circuit protective device may be an indication that a fault has been interrupted. To reduce the risk of fire or electric shocks,

current-carrying parts and other components of the device should be examined and replaced if damaged. If burnout of the device occurs, the complete device must be replaced or equivalent.

FUSES/ FUSES HOLDER

HIGH SPEED FUSES					FUSE HOLDER		
Model	Size I ^T	Code Format	Model Code	Dissipated power @ In	Model Code Approval	Max power dissipated	Max continuative current
GQ15...	16A 150A ² S	FUS-016 10x38	FWC16A10F 338470	3,5W	PFI-10x38 337134 UR 30A@690V	3W	13A
GQ25...	25A 390A ² S	FUS-025 10x38	FWC25A10F 338474	6W			13A
	375A ² S	FUS-026 14x51	FWC25A14F 338130	7W	PFI-14x51 337503 UR 50A@600V	5W	18A
GQ50...	50A 1800A ² S	FUS-051 14x51	FWC50A14F 338079	9W	PFI-22x58 337223 UR 80A@600V		9,5W
	50A 1600A ² S	FUS-050 22x58	FWC50A22F 338127	9,5W		50A	
GQ75...	80A 6600A ² s	FUS-80 22x58	FWP80A22F 338199	14W			50A
GQ90...	80A 6600A ² S	FUS-080 22x58	FWP80A22F 338199	14W			50A
	100A 12500A ² S	FUS-100 22x58	FWP100A22F 338478	16W			60A

HEATSINK/ THERMAL RESISTANCE

Model	GEFRAN HEATSINK (see accessories)	THERMAL RESISTANCE
GQ15...	DIS 25GD	$R_{th} \leq 2,8 \text{ K/W}$
GQ25...	DIS 50G	$R_{th} \leq 0,83 \text{ K/W}$
GQ50...	DIS 50G	$R_{th} \leq 0,83 \text{ K/W}$
GQ75/90...	DIS 90G	$R_{th} \leq 0,56 \text{ K/W}$

Data relating to 40°C ambient temperature, heatsink in vertical position with 15 cm of free air above and below.

SECTION CABLE

Model	Section
GQ15...	2,5mm ²
GQ25...	6mm ²
GQ50...	12mm ²
GQ75/90...	25mm ²

Minimum allowed rated section based on the rated currents of the power solid state relays, for copper leads isolated in PVC in continuous use and at room temperature of 40°C, according to standards CEI 44-5, CEI 17-11, IEC 408 pursuant to standard EN60204-1.

Power terminals in compliance with standard EN60947-1

REFERENCE NORMS

EMC Emission		
EN 61000-6-4	Emissions conducted at radiofrequency	Class A (Industrial devices)
EN 61000-6-4	Emissions irradiated at radiofrequency	Class A (Industrial devices)
The product is designed for type A environments. Use of the product in type B environments may cause undesired electromagnetic noise. In this case, the user should take appropriate steps for improvement.		
EMC Immunity		
EN 61000-6-2	Immunity for industrial environments	
EN 61000-4-2	Electrostatic discharges	4kV by contact; 8 kV in air. Performance criterion 2.
EN 61000-4-6	Electromagnetic field at radiofrequency 0,15-80MHz	Test level 3. Performance criterion 1.
EN 61000-4-3	Electromagnetic field at radiofrequency 80-1000MHz	Test level 10V/m. Performance criterion 1.
EN 61000-4-4	Immunity to burst	LTest level 2kV/100 KHz. Performance criterion 2.
EN 61000-4-5	Immunity to surge	Test level: 2kV (Phase-ground); 1kV (Phase-phase). Performance criterion 2.
Safety		
EN 61010-1	Safety requirements	

DISSIPATION CURVES

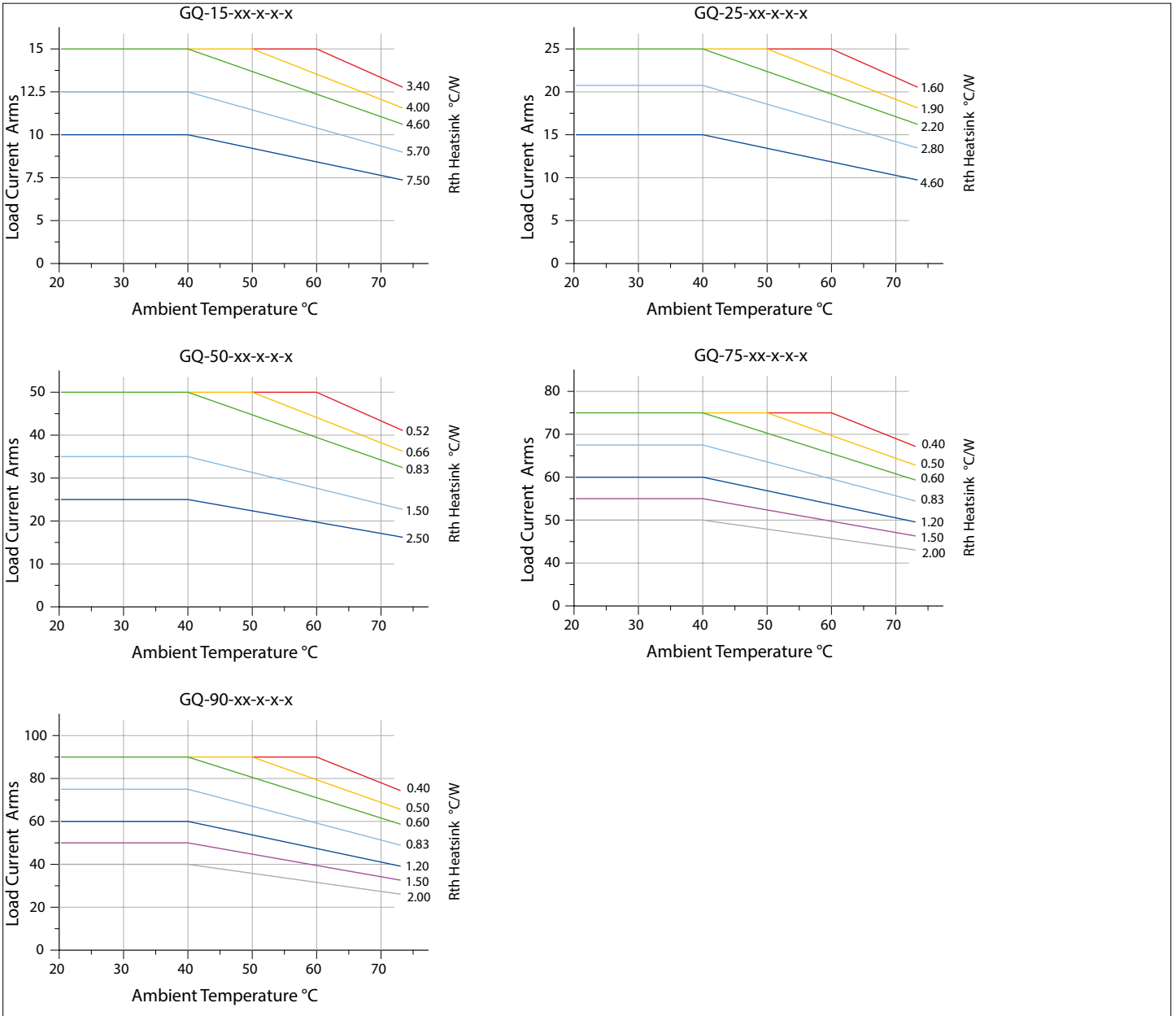

ORDER CODE

<table border="1" style="width: 100%; border-collapse: collapse;"> <tr> <th colspan="2" style="text-align: center;">MODEL</th> </tr> <tr> <td style="width: 70%;"></td> <td style="text-align: center;">GQ</td> </tr> </table> <table border="1" style="width: 100%; border-collapse: collapse;"> <tr> <th colspan="2" style="text-align: center;">NOMINAL CURRENT</th> </tr> <tr> <td>15ACArms</td> <td style="text-align: center;">15</td> </tr> <tr> <td>25ACArms</td> <td style="text-align: center;">25</td> </tr> <tr> <td>50ACArms</td> <td style="text-align: center;">50</td> </tr> <tr> <td>75ACArms</td> <td style="text-align: center;">75</td> </tr> <tr> <td>90ACArms</td> <td style="text-align: center;">90</td> </tr> </table> <table border="1" style="width: 100%; border-collapse: collapse;"> <tr> <th colspan="2" style="text-align: center;">NOMINAL VOLTAGE</th> </tr> <tr> <td>230VACrms</td> <td style="text-align: center;">24</td> </tr> <tr> <td>480VACrms</td> <td style="text-align: center;">48</td> </tr> <tr> <td>600VACrms (*)</td> <td style="text-align: center;">60</td> </tr> </table> <p>(*) Available only in versions GQ-XX-60-X-1-X (overloading protection always present) Please, contact GEFTRAN sales people for the codes availability</p>	MODEL			GQ	NOMINAL CURRENT		15ACArms	15	25ACArms	25	50ACArms	50	75ACArms	75	90ACArms	90	NOMINAL VOLTAGE		230VACrms	24	480VACrms	48	600VACrms (*)	60	<table border="1" style="width: 100%; border-collapse: collapse;"> <tr> <th colspan="2" style="text-align: center;">CONNECTORS</th> </tr> <tr> <td style="text-align: center;">0</td> <td>Without connector</td> </tr> <tr> <td style="text-align: center;">1</td> <td>(MORS1) Two-pin spring connector, enclosed</td> </tr> <tr> <td style="text-align: center;">2</td> <td>(MORS2) Two-pin double spring connector, enclosed</td> </tr> <tr> <td style="text-align: center;">3</td> <td>(MORS3) Two-pin screw connector, enclosed</td> </tr> <tr> <td style="text-align: center;">4</td> <td>(MORS4) Two-pin PUSH-IN connector, low profile enclosed</td> </tr> </table> <table border="1" style="width: 100%; border-collapse: collapse;"> <tr> <th colspan="2" style="text-align: center;">OVERVOLTAGE PROTECTION</th> </tr> <tr> <td style="text-align: center;">0</td> <td>External</td> </tr> <tr> <td style="text-align: center;">1</td> <td>Internal</td> </tr> </table> <table border="1" style="width: 100%; border-collapse: collapse;"> <tr> <th colspan="2" style="text-align: center;">CONTROL VOLTAGE</th> </tr> <tr> <td style="text-align: center;">D</td> <td>3...32Vc.c.</td> </tr> <tr> <td style="text-align: center;">A</td> <td>20...260Vac/Vcc</td> </tr> </table>	CONNECTORS		0	Without connector	1	(MORS1) Two-pin spring connector, enclosed	2	(MORS2) Two-pin double spring connector, enclosed	3	(MORS3) Two-pin screw connector, enclosed	4	(MORS4) Two-pin PUSH-IN connector, low profile enclosed	OVERVOLTAGE PROTECTION		0	External	1	Internal	CONTROL VOLTAGE		D	3...32Vc.c.	A	20...260Vac/Vcc	<div style="text-align: center; margin-bottom: 10px;"> GQ </div>
MODEL																																																		
	GQ																																																	
NOMINAL CURRENT																																																		
15ACArms	15																																																	
25ACArms	25																																																	
50ACArms	50																																																	
75ACArms	75																																																	
90ACArms	90																																																	
NOMINAL VOLTAGE																																																		
230VACrms	24																																																	
480VACrms	48																																																	
600VACrms (*)	60																																																	
CONNECTORS																																																		
0	Without connector																																																	
1	(MORS1) Two-pin spring connector, enclosed																																																	
2	(MORS2) Two-pin double spring connector, enclosed																																																	
3	(MORS3) Two-pin screw connector, enclosed																																																	
4	(MORS4) Two-pin PUSH-IN connector, low profile enclosed																																																	
OVERVOLTAGE PROTECTION																																																		
0	External																																																	
1	Internal																																																	
CONTROL VOLTAGE																																																		
D	3...32Vc.c.																																																	
A	20...260Vac/Vcc																																																	

GEFRAN spa reserves the right to make any kind of design or functional modification at any moment without prior notice

•WARNINGS

WARNING: this symbol indicates danger.

Before installation, please read the following advices:

- follow the indications of the manual scrupulously when making the connections to the instrument.
- use a cable that is suitable for the ratings of voltage and current indicated in the technical specifications.
- if the instrument is used in applications where there is risk of injury to persons and damage to machines or materials, it is essential that it is used with an auxiliary alarm device.
- It is advisable to verify frequently that the alarm device is functional even during the normal operation of the equipment.
- The instrument must NOT be used in environments where there could be the presence of dangerous atmospheres (inflammable or explosive)
- During continuous operation, the heatsink may reach 100°C and remain at a high temperature due to thermal inertia even after the device is switched off. Therefore, DO NOT touch the heat sink or the electrical wires.
- do not operate on the power circuit unless the main supply is disconnected.
- DO NOT open the cover if device is "ON"!

Installation:

- connect the device to the ground using the proper ground terminal;
- the power supply wiring must be kept separate from that of inputs and outputs of the instrument; always check that the supply voltage corresponds to that indicated on the instrument cover;
- keep away from dust, humidity, corrosive gases and heat sources;
- is recommended in the electrical panel containing the GQ, install a fan near the group of GQ that keep air in movement.

Maintenance

- Check the correct operation of the cooling fans at regular intervals; clean the ventilation air filters of the installation at regular intervals
- Repairs must be performed only by specialized or appropriately trained personnel. Cut off power to the device before accessing internal parts.
- Do not clean the box with solvents derived from hydrocarbons (trichloroethylene, gasoline, etc.).
Using such solvents will compromise the mechanical reliability of the device. To clean external plastic parts, use a clean cloth wet with ethyl alcohol or water

Technical service:
GEFRAN has a technical service department. Defects caused by use not conforming to the instructions are excluded from the warranty.

	This device conforms to European Union Directive 2014/30/EU and 2014/35/EU as amended with reference to generic standards: EN 61000-6-2 (immunity in industrial environment) EN 61000-6-4 (emission in industrial environment) - EN 61010-1 (safety regulations).
	Conformity UL508 - File: E243386
	100 KA when protected by proper fuse
	Conformity TC RU C-IT.AJ32.B.00422