



Dimensions 96 × 96 × 80 mm (1/4 DIN)

Main features

- **Operator interface with large LCD Display, customizable, with choice of colors**
- **Scrolling diagnostics messages, configurable, in the selected language**
- **Easy, guided configuration, copy/paste parameters even with power off**
- **Preventive maintenance with energy counters (kWh) and load switching**
- **16 function block applications**
- **Timer, setpoint and algorithm programmer for controlling motorized valves**
- **Advanced tuning of control parameters**
- **Different password levels**
- **Universal input configurable for thermocouples, resistance thermometers, linear inputs**
- **Remote setpoint input**
- **Relay, logic, isolated analog outputs**
- **Up to two CT inputs for interrupted load diagnostics**
- **RS485 serial communication in Modbus RTU**
- **Removable faceplate for immediate replacement**
- **Sampling time 60 ms**

PROFILE

Operator interface

Large LCD display with customization of colors assigned to PV, SV and F display, of color of plastic faceplate, and of logo. Graphic display of power, output current or valve position. Scrolling alphanumeric display of 25 messages (32 letters each), completely configurable and savable, in three languages. Thanks to language selection and clear scrolling messages for diagnostics, alarms, and process state, the controller speaks the user's language.

Easy Configuration

Guided configuration for manual-free programming, with a few essential parameters and on-line help messages.

Ability to clone configuration among controllers, even with power off and in the field, thanks to a mini portable configurator with Zapper battery.

Extended configuration, creation of work recipes, and firmware updates via PC and GF_eXpress software, even without powering the controllers.

Thanks to the Smart Configurator function, you obtain the required parameter recipe by answering a few simple questions.

Local configuration and operation with only four keys assigned to LEDs that serve as feedback for the pressed key and as guide to specify appropriate steps.

The initial parameters can always be reset, both from the keypad and from the GF_eXpress Software tool.

Diagnostics, Preventive Maintenance, and Energy Monitor

Complete diagnostics for broken or incorrectly connected probe, total or partial load break, out of range variables, and control loop faults.

Thanks to the switching count and to the settable alarm thresholds, you can program preventive maintenance to replace worn actuators.

An internal energy counter with alarm for abnormal variations totalizes energy consumptions and costs for constant control

Function block applications

Sixteen AND, OR, Timer Function Blocks let you create customizable logic sequences for complete and flexible machine control.

The controller's hardware resources are exploited completely, without any need for external devices such as timers and small PLCs

Tuning

Advanced tuning algorithms ensure stable and accurate control even with critical or very rapid thermal systems, engaging automatically when necessary.

Timer

Three types of timers let you set delay times before activating the control, hold times on the setpoint value, and timed changes of programmed setpoints.

Setpoint Programmer

Models with twelve ramp and hold steps, groupable in four programs, with enable inputs and event outputs, are available for applications with setpoint profiles.

The operator interface provides two additional display dedicated to the permanent display for: Nr. of step and Nr. program.

On-board configuration and graphic configuration with GF_eXpress.

Valve Positioner

Models to control motorized valves, without feedback.

Valve position is calculated and shown on the display.

General characteristics

The controller is completely software configurable without accessing the internal electronics.

The universal main input accepts thermocouple sensors, resistance thermometers, and linears.

The controller can be replaced at any time simply by removing the faceplate, without any additional procedures.

DISPLAY AND KEYS

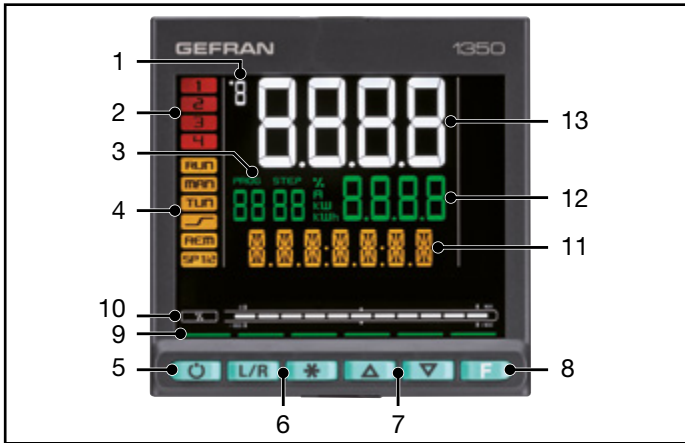

1. Temperature unit of measurement or number of program running.
2. State of outputs OUT1, OU2, OUT3, OUT4.
3. Displays program number, step number, unit of measurement (% , A, kW, kWh).
4. Controller function states:
 - RUN = setpoint programmer active;
 - $_/-$ = setpoint ramp active;
 - TUN = PID parameters tuning active;
 - MAN = manual/automatic (off = automatic control, on = manual control);
 - REM = remote setpoint enabled;
 - SP1/2 = setpoint active (off = setpoint 1, on = setpoint 2).

5. Work mode key (manual/automatic) in standard mode. A function can be assigned via parameter but1. The key is active only when the display shows the process variable.
6. Key function configurable with parameters but2 and but3. The keys are active only when the display shows the process variable.
7. Up/down keys: raise/lower the value of the parameter displayed on the SV or PV display.
8. F key: lets you navigate among controller menus and parameters. Confirms the parameter value and selects the next parameter.
9. Key pressed signals.
10. Displays percentage of power or current, configurable with parameter bARG.
11. Display F: parameters, diagnostics and alarm messages. Configurable with parameter dS.F (default = setpoint).
12. SV display: parameter values. Configurable with parameter dS.SP (default = setpoint).
13. PV display: process variable.

DIMENSIONS AND DRILLING TEMPLATE

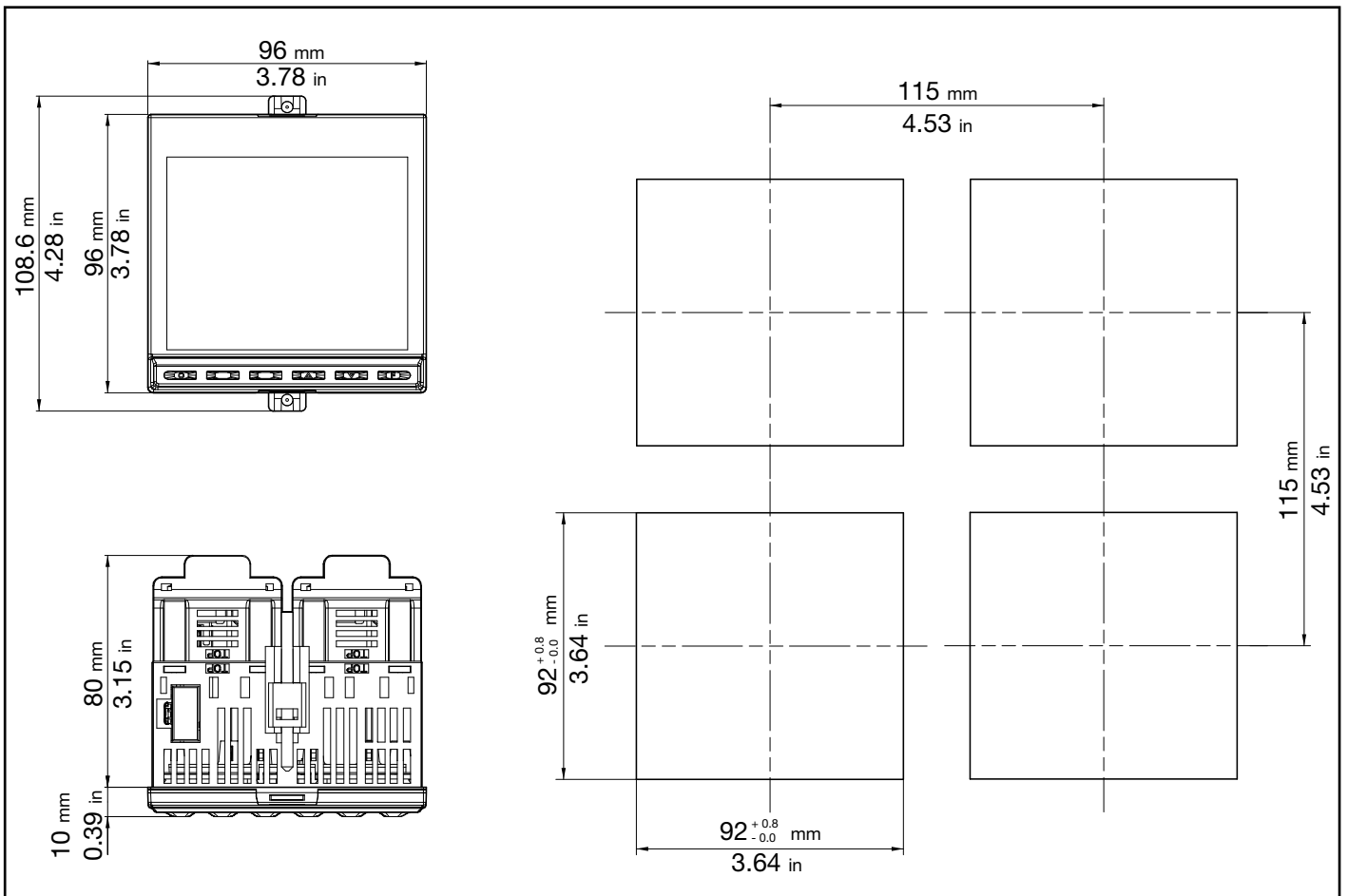

TECHNICAL DATA

OPERATOR INTERFACE		
DISPLAY	Type	LCD black background
	Screen area (L x H)	83 × 68 mm
	Lighting	Backlit with LEDs, life > 40,000 hours @ 25°C
	PV display	Number of digits: 4 to 7 segments, with decimal point Digit height: 23 mm Color: white or "custom"
	SV display	Number of digits: 4 to 7 segments, with decimal point Digit height: 11 mm Color: green or "custom"
	F display	Number of digits: 7 to 14 segments, with decimal point Digit height: 9 mm Color: amber or "custom"
	Unit of measurement	Selectable, °C, °F or custom 1 Color: same as PV display
	Controller state signals	Number: 6 (RUN, MAN, _/-, REM, SP1/2) Color: amber
	Output state signals	Number: 4 (1, 2, 3, 4) Color: red
Bargraph indicator, configurable	Type: graphic bargraph, 11 segments Power indication: 0...100% or -100...100% Current indication: 0...100% f.s. Valve position indication: 0...100%	
KEYPAD		Keys number: 6, silicone (Man/Auto, INC,DEC,F) Type: mechanical
INPUTS		
MAIN INPUT	Sensor type	TC, RTD (PT100, JPT100), infrared sensor, DC linear sensor
	Accuracy	TC inputs: Calibration accuracy: < +/- (0,25% of reading value in °C +0,1°C) Linearization accuracy: 0,1% of reading value Cold junction accuracy: < +/- 1,5°C a 25°C room temperature) Cold junction compensation: > 30:1 rejection to the change of the room temperature RTD input: Calibration accuracy: < +/- (0,15% of reading value in °C +1°C) Temperature drift: < +/- (0,005% of reading value in °C +0,015°C)/°C from 25°C room temperature Linearization accuracy: 0,1% of reading value Linear inputs: Calibration accuracy:< 0,1% full scale Temperature drift: < +/- 0,005% full scale /°C at 25°C room temperature
	Sampling time	60 ms / 120 ms, selectable
	Digital filter	0,0...20,0 s
	Temperature unit of measurement	Degrees C / F, selectable from keypad
	Signal interval	Type: linear Scale: -1999...9999, settable decimal point
	TC (thermocouple) input	Thermocouple: J, K, R, S, T, C, D Linearization: ITS90 or custom
	RTD (resistance thermometer) input	Resistance thermometer: PT100, JPT100 Input impedance (Ri): ≥ 30 kΩ Linearization: DIN 43760 or custom Max. line resistance: 20 Ω
	DC linear input	0...60 mV input impedance (Ri): > 70 kΩ 0...1 V input impedance (Ri): > 15 kΩ 0...5 V / 0...10 V input impedance (Ri): > 30 kΩ 0/4...20 mA input impedance (Ri): 50 Ω Linearization: linear or custom
AUXILIARY INPUT	Remote setpoint	0...1 V, 0...10 V, 0/4...20 mA
	Scale	0...1 V input impedance (Ri): > 15 kΩ 0...10 V input impedance (Ri): > 30 kΩ 0/4...20 mA input impedance (Ri): 50 Ω
	Accuracy	0,1% f.s. ±1 digit @25 °C

CT (ammeter) input	Type	Isolated via external transformer
		Number: 2 max Max. capacity: x / 50 mA AC Line frequency: 50/60 Hz Input impedance (Ri): 10 Ω
	Accuracy	±2% f.s. ±1 digit @25 °C
DIGITAL INPUTS	Type	voltage-free contact, or NPN 24 V - 4,5 mA, or PNP 12/24 V - max 3,6 mA <i>(for detail see electrical connections)</i>
	Isolation	500 V
	Number	5 max
OUTPUTS		
	Relay (R)	Number: 4 max Type of relay contact: NO Max. current: 5 A, 250 VAC / 30 VDC, $\cos\phi = 1$ Minimum load: 5 V, 10 mA Life cycle: > 100.000 operations Double isolation
	Logic (D)	Number: 2 max Type: for solid-state relays Voltage: 24 V ±10% (min 10 V @20 mA) Isolated from main input
	Triac (long life relè) (T)	Number: 1 max Load: resistive Voltage: 75...264 VAC; Current max: 1 A Isolation 3 kV circuito snubber integrato zero crossing switching
	Continuous (C)	Number: 1 max Current: 4...20mA $R_{out} < 500 \Omega$ Resolution: 12 bit Isolated from main input
	Analog retransmission (A1)	Number: 1 max 0...10 V, max 20 mA, $R_{out} > 500 \Omega$ 0...20 mA, 4...20 mA, $R_{out} < 500 \Omega$ Resolution: 12 bit Isolated from main input
ALARMS	Number of alarm functions	4 max, assignable to an output
	Possible configurations	Maximum, minimum, symmetric, absolute/relative, exclusion at firing, memory, reset from keypad and/or contact, LBA, HB HBB Hold Back Band if enabled with Programmer function
CONTROL FUNCTIONS		
CONTROL	Type	Single loop
	Control	PID, ON/OFF, single action heat or cool, double action heat/cool
	Control output	Continuous or ON/OFF Cycle time: constant or optimized (BF)
	Control output for motorized valves	OPEN/CLOSE for floating motorized valve on Relay, Solid-state, Triac outputs
SETPOINT PROGRAMMER	Number of programs	Max 4 Start / Stop / Reset / Skip via digital inputs and/or outputs from logic operations Output state: Run /Hold / Ready / End
	Number of steps	Max 12, each with own setpoint, ramp time and hold time Times settable in HH:MM or MM:SS Max 4 consents, configurable for ramp and for hold Max 4 events, configurable in ramp and in hold
MULTIPLE SETPOINTS	Number of setpoints	Max 4, selectable from digital input Each setpoint change is subject to set ramp, different for up and down ramp

1) Programming is done with the GF_eXpress configuration program.

LOGIC 1 OPERATIONS	Function blocks	Max 16, with 4 input variables per block. The result can act on the state of the controller, of the programmer on alarms and outputs. Each function contains an incorporated timer block timer.
TIMER FUNCTION	Modes	START / STOP STABILIZATION (timer is on when PV enters a band set around setpoint; at end of count you can activate an output, shut down SW or change SP1/SP2) FIRING (timed activation of control after power on)
ENERGY COUNTER		Calculation done on nominal line voltage and nominal load power or on rms current measured on load via CT
DIAGNOSTIC		Short circuit or open circuit (LBA alarm) Interrupted or partially interrupted load (HB alarm) Short circuit of control output (SSR alarm)
RETENTIVE MEMORY	Type	EEPROM
	Max. number of writes	1.000.000
SERIAL INTERFACE		
	Type	RS485
	Baudrate	1200, 2400, 4800, 9600, 19.200, 38.400, 57.600, 115.200 bit/s
	Protocoll	MODBUS RTU
		Isolated from main input

GENERAL DATA

POWER SUPPLY	Operating voltage	100...240 VAC/VDC \pm 10%, 50/60 Hz (on request 20...27 VAC/VDC \pm 10%)
	Power dissipation	10 W max
	Protections	Overvoltage 300 V / 35 V
	Connection	Screw terminals and crimp connector, max. wire section 1 mm ²
CONNECTIONS	Serial configuration port (for USB connection)	Connector: microUSB
	Inputs and outputs	Screw terminals and crimp connector, max. wire section 2,5 mm ²
AMBIENT CONDITIONS	Use	Indoor
	Altitudine	2000 m max
	Operating temperature	-10 ... +55 °C (as per IEC 68-2-14)
	Storage temperature	-20 ... +70 °C (as per IEC 68-2-14)
	Relative humidity	20...85% RH non-condensing (as per IEC 68-2-3)
PROTECTION LEVEL		IP 65 on front panel (as per IEC 68-2-3)
ASSEMBLY	Positioning	On panel, removable faceplate
	Installation regulations	Installation category: II; Pollution degree: 2 Isolation: double
DIMENSIONS		96 X 96 mm (1/4 DIN) Depth: 80 mm
WEIGHT		0,24 kg
CE STANDARDS	EMC (electromagnetic compatibility)	Conforms to directiv 2014/30/EU with reference to standard EN 61326-1 emission in industrial environment class A
	Safety: LVD	Conforms to directiv 2014/35/EU with reference to standard EN61010-1

ACCESSORIES

Code	Description
F060800	Cable for programming with PC, USB-TTL 3 V with USB – microUSB connectors, length 1.8 m
F043958	“GF_eXpress” software CD
F060909	Configuration kit for new instruments GF_eXK-3-0-0
F060908	Portable configurator, complete with cable and Zapper
51970	Rubber gasket 96×96 front box
51069	Rubber gasket 99×96 box-panel
49030	Fastening box to panel
51328	Protection of contacts at box bottom
51738	36 contacts at box bottom
330200	Current transformer (CT) 50/0.05 A
330201	Current transformer (CT) 25/0.05 A

CONNECTION DIAGRAM

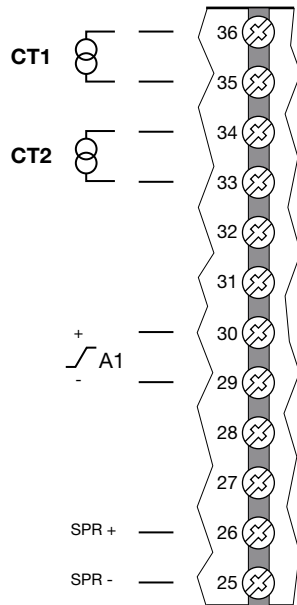
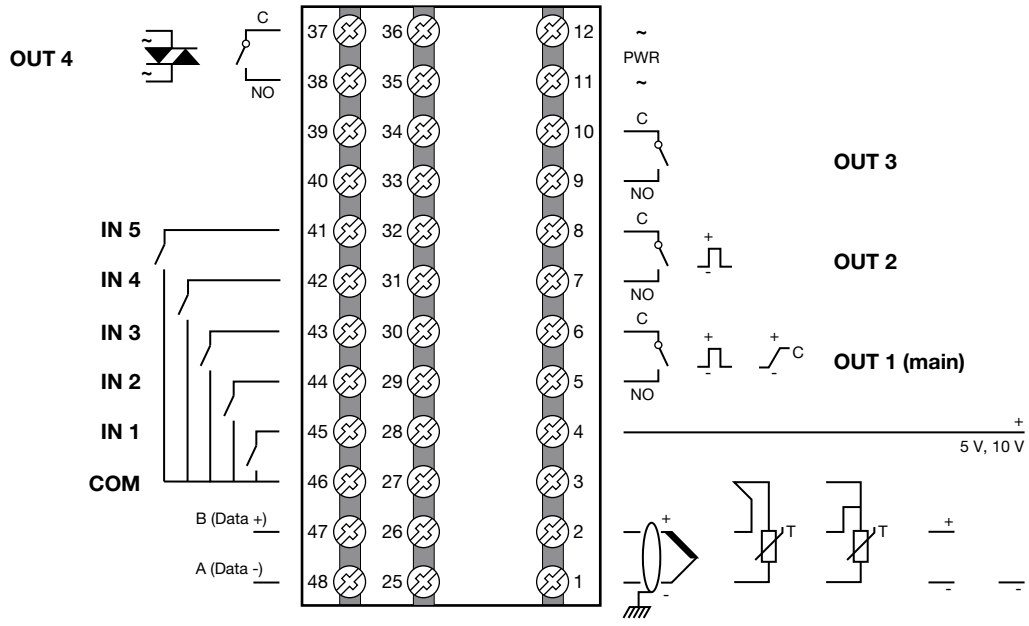

LEGEND

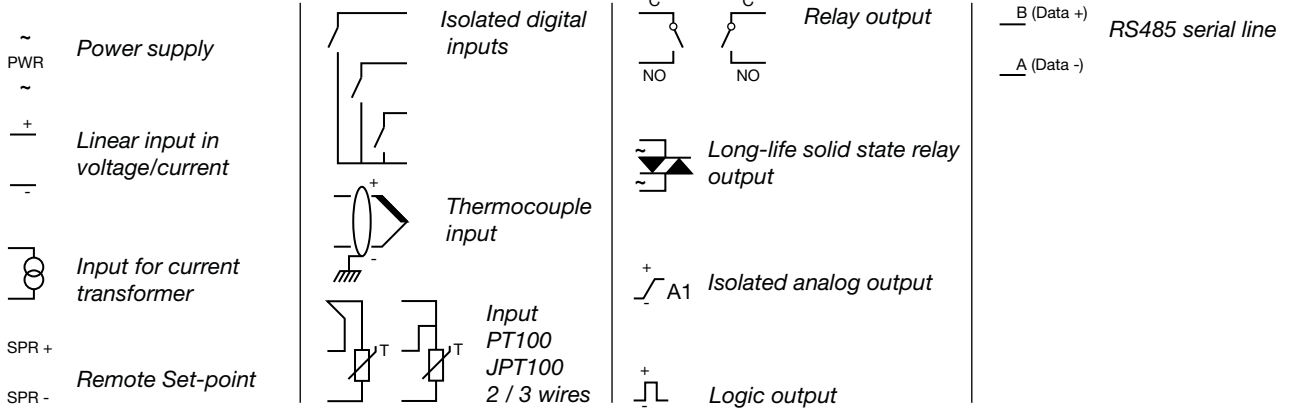

ATTENTION: For correct installation, read the warnings in the instruction manual.

ORDER METHODS

Ordering code **1350** X-X-X X X-X-X X X X-X-X X X

Model	
Controller	-
Programmer	P
Valve	V

Output 1	
Relay	R
Static	D
Analog 4...20mA	C

Output 2 - 3 - 4	
1 Relay (5A)	R-0-0
1 Static	D-0-0
2 Relay (5A)	R-R-0
1 Static + 1 relay (5A)	D-R-0
2 Relay (5A) + 1 Long Life relay	R-R-T
1 Static + 1 relè (5A)+ 1Long Life relay	D-R-T
1 Static + 2 relay (5A)	D-R-R
3 Relay (5A)	R-R-R

Remote Set Point	
Absent	0
SPR 0/4...20mA / 0...10	1

W retransmission	
Absent	0
W 0/4...20mA / 0...10V	1

CT inputs	
Absent	0
CT1	1
CT1+CT2	2

Digital inputs	
Absent	0
5 DI	5

Serial communication	
Absent	0
RS485	1

Supply	
20-27Vac/dc	0
100-240Vac	1

Functions	
Logical operations	LF

Display	
Green setpoint	G

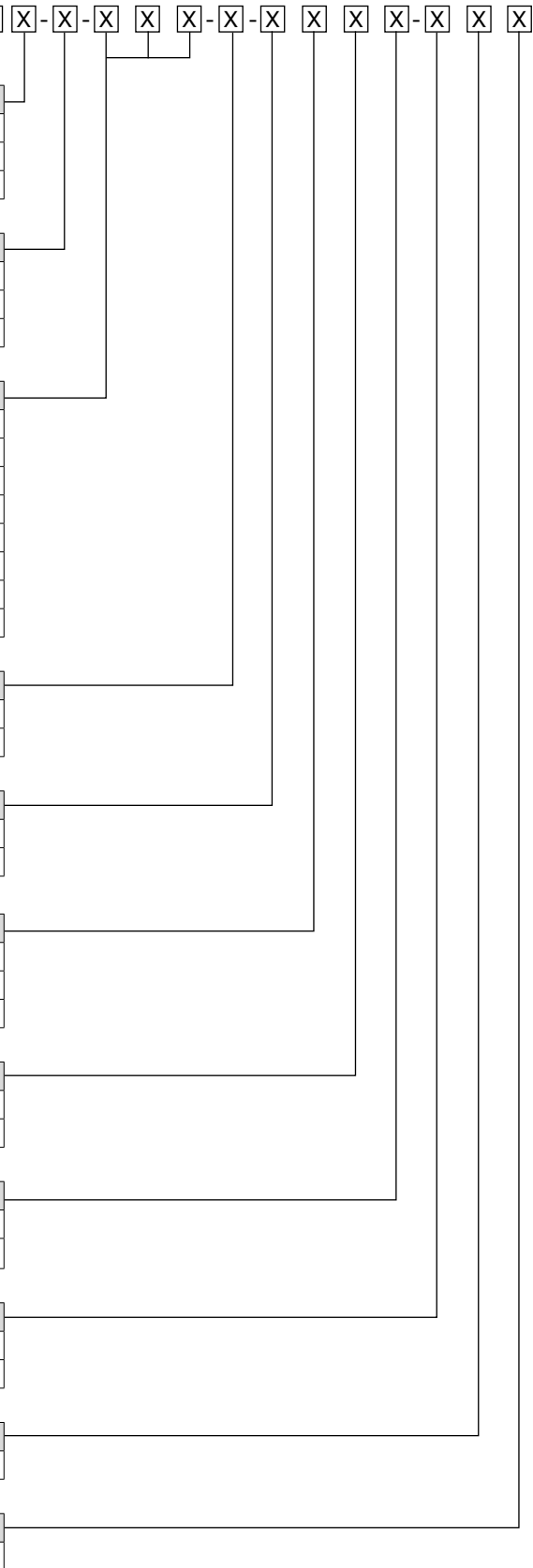



Power supply 100...240 VAC/VDC

Code F	Model	Valves	Programmer	Inputs			Outputs					RS485	Logic functions	Total Number of Outputs
				Digital	CT	SPR	Relay	Triac	Logic	Analog I	Analog V/I			
F061830	1350-D-R00-00000-1-G						1		1					2 outputs
F061831	1350-R-R00-00000-1-G						2							
F061832	1350-D-R00-00150-1-G			5	1		1		1					
F061833	1350-D-RR0-00000-1-G						2		1					3 outputs
F061834	1350-R-RR0-00000-1-G						3							
F061835	1350-D-RR0-00050-1-G			5			2		1					
F061836	1350-D-RR0-00200-1-G				2		2		1					
F061837	1350-C-RR0-00000-1-G						2			1				
F061838	1350-D-R00-01050-1-G			5			1		1		1			
F061839	1350-R-R00-01050-1-G			5			2				1			
F061840	1350-R-RR0-00101-1-G				1		3					•		
F061841	1350-D-RRR-00000-1-G						3		1					
F061842	1350-R-RRR-00000-1-G						4							4 outputs
F061843	1350-R-RRT-00000-1-G						3	1						
F061844	1350-D-RRR-00250-1LFG			5	2		3		1			•	•	
F061845	1350-D-RRR-00051-1LFG			5			3		1			•	•	
F061846	1350-C-DRR-00051-1LFG			5			2		1	1		•	•	
F061847	1350-D-RRR-00201-1LFG				2		3		1			•	•	
F061848	1350-C-RRR-10050-1LFG			5		1	3			1			•	
F061849	1350V-R-RRR-00000-1-G	•					4							
F061850	1350V-R-RRR-00050-1-G	•		5			4							
F061851	1350P-D-RRR-00000-1-G		•				3		1					
F061852	1350P-D-RRR-00050-1LFG		•	5			3		1				•	
F061853	1350-D-RRR-01050-1LFG			5			3		1		1		•	5 outputs

Power supply 20...27 VAC/VDC

Code F	Model	Valves	Programmer	Inputs			Outputs					RS485	Logic functions	Total Number of Outputs
				Digital	CT	SPR	Relay	Triac	Logic	Analog I	Analog V/I			
F061854	1350-D-R00-00000-0-G						1		1					2 outputs
F061855	1350-R-R00-00000-0-G						2							
F061856	1350-D-R00-00150-0-G			5	1		1		1					
F061857	1350-D-RR0-00000-0-G						2		1					3 outputs
F061858	1350-R-RR0-00000-0-G						3							
F061859	1350-D-RR0-00050-0-G			5			2		1					
F061860	1350-D-RR0-00200-0-G				2		2		1					
F061861	1350-C-RR0-00000-0-G						2			1				
F061862	1350-D-R00-01050-0-G			5			1		1		1			
F061863	1350-R-R00-01050-0-G			5			2				1			
F061864	1350-R-RR0-00101-0-G				1		3					•		
F061865	1350-D-RRR-00000-0-G						3		1					
F061866	1350-R-RRR-00000-0-G						4							4 outputs
F061867	1350-R-RRT-00000-0-G						3	1						
F061868	1350-D-RRR-00250-0LFG			5	2		3		1			•	•	
F061869	1350-D-RRR-00051-0LFG			5			3		1			•	•	
F061870	1350-C-DRR-00051-0LFG			5			2		1	1		•	•	
F061871	1350-D-RRR-00201-0LFG				2		3		1			•	•	
F061872	1350-C-RRR-10050-0LFG			5		1	3			1			•	
F061873	1350V-R-RRR-00000-0-G	•					4							
F061874	1350V-R-RRR-00050-0-G	•		5			4							
F061875	1350P-D-RRR-00000-0-G		•				3		1					
F061876	1350P-D-RRR-00050-0LFG		•	5			3		1				•	
F061877	1350-D-RRR-01050-0LFG			5			3		1		1		•	5 outputs

Please contact GEFTRAN for information on available codes.

	Conformity TC N° РУД-ИТ.АЛ32.б.01762
	Conformity C/UL/US File no. E216851
	EMC (electromagnetic compatibility): conforms to directive 2014/30/EU with reference to standard EN 61326-1 emission in industrial environment class A Safety LVD: conforms to directive 2014/35/EU with reference to standard EN61010-1

SOUTHWEST HEATER AND CONTROLS

10610 Control Place, Dallas Texas 75238

Main# 214-340-7500

Toll Free#: 800-687-2220

EMAIL: sales@swhc.com

WEB: www.swhc.com